



Schindler 3300

A flexible standard solution that unifies form and function. Our passenger elevator for residential and commercial buildings.



Key figures

Capacity	400-1125 kg, 5-15 passengers
Travel height	Max. 75 m, max. 20 floors
Entrances*	One- or two-sided
Door width*	750mm, 800mm, 900mm
Door height*	2000 mm, 2100 mm
Car height	2135 mm
Drive system	Eco-friendly gearless machine, frequency controlled, machine room-less
Speed	1.0 m/s, 1.6 m/s
Interior	Two style sets and three décor lines or Libertà concept
Flex edition	Extended car and door flexibility

* For possible combinations, see the planning data on page 28.

NEW

The essentials for comfortable mobility

Solid performance

The Schindler 3300 was designed to meet Swiss standards of precision – reliability is built in. Enjoy worry-free operation day in and day out.

Space efficiency

A larger car for standard-sized shafts. Smaller technical components allow roomier car dimensions and more personal space for passengers.

Green mobility

Engineered to be energy efficient and eco-friendly. A quieter ride means less noise pollution as well.

Choice of design

Choose an interior style from our ready-made décor lines or create your own. Either way, it's a perfect match.

Solid performance

Schindler's best selling elevator since 2006 – a true technological evolution. Highly standardized yet flexible to install. System engineered with components built to fit together. The result: a smooth and silent ride for passengers in residential and mid-size commercial buildings.

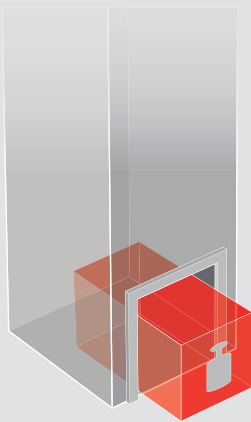

Full capacity

up to 1125 kg
up to 15 passengers

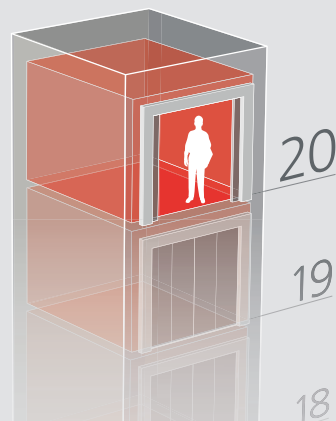

New heights

75 meters
20 stops

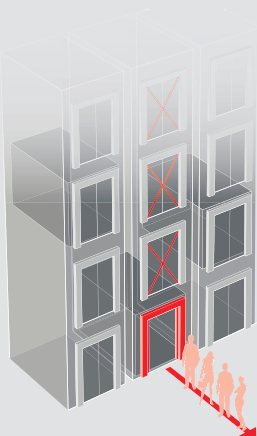

Convenient operation

Automatic evacuation
Automatic re-leveling

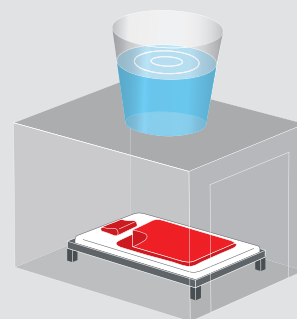

Smooth operation

1.0 m/s, 1.6 m/s
Silent and smooth
running

Space efficiency

Less space creates more room. Specifically designed to minimize the space required for technical equipment. The control cabinet fits into the landing door frame and the drive is directly installed in the shaft, eliminating the machine room.

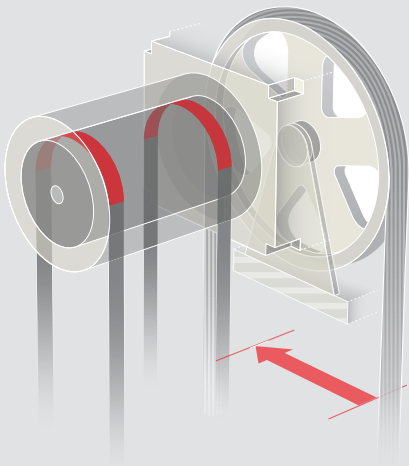

The Suspension Traction Media (STM) enables a smaller traction diameter of 85 mm, translating into a smaller motor size.

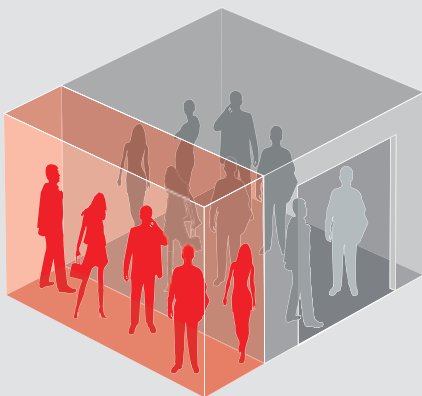

Less space for components, more room for the passengers. Up to 25 cm wider car that still fits in standard-sized shafts.

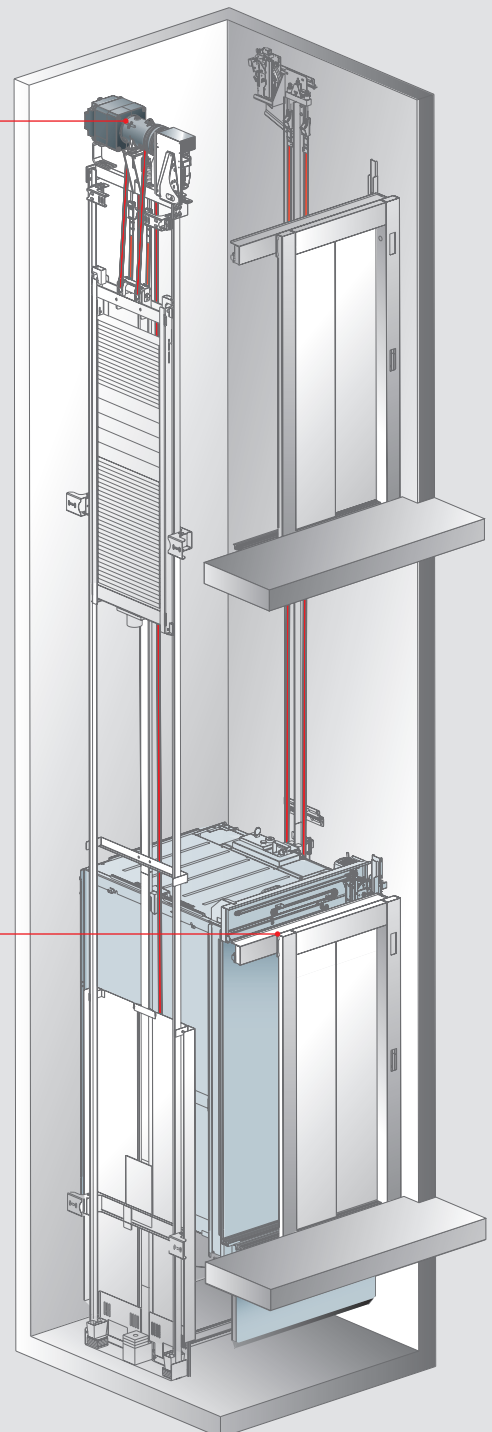

Shaft dimensions* width x depth	Previous		New	
	Passengers	Capacity	Passengers	Capacity
1400 x 1450 mm	4	320 kg	+	5 400 kg
1500 x 1600 mm	6	450 kg	+	7 535 kg
1500 x 1650 mm	6	450 kg	+	7 535 kg
1600 x 1600 mm	6	450 kg	+	8 625 kg
1600 x 1650 mm	6	450 kg	+	8 625 kg
1600 x 1750 mm	8	630 kg	+	9 675 kg
1650 x 2450 mm	13	1000 kg	+	15 1125 kg
1800 x 1700 mm	8	630 kg	+	10 800 kg
2000 x 1700 mm	8	630 kg	+	13 1000 kg

* Applicable to cars with one-sided entrance and speed of 1 m/s

Green mobility

Caring for tomorrow starts today. The Schindler 3300 is a lightweight elevator free from harmful substances and designed for low everyday energy consumption. The operating efficiency remains steady over the course of its lifetime – and this elevator is almost 100% recyclable.

up to 30%



Clean drive technology

Thanks to the regenerative PowerFactor 1 drive technology, the Schindler 3300 uses up to 30% less travel energy compared to conventional technology. Excessive energy is “clean”, allowing it to be fed back to the grid without causing equipment interference due to harmonic distortion.

up to 40%



Standby mode

When not in use, the Schindler 3300 consumes up to 40% less energy for inverter, controls, lights and ventilation. Wake up is instantaneous.

up to 20x

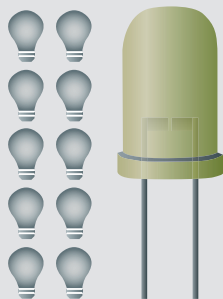

LED lighting

LED lights have an extremely long service life, up to 20 times longer than standard light bulbs, while consuming less energy. All ceilings and operating panels in the Schindler 3300 are equipped with LED lights as standard.



Energy efficient operation

Superior everyday performance should not be synonymous with higher energy consumption – and with the Schindler 3300 it is not. Thanks to its lightweight system, precision engineering and energy-saving features, the Schindler 3300 achieved an A-classification for energy efficiency according to the VDI 4707-1 standard.*

* The VDI 4707-1 standard regarding the energy efficiency of lifts is established by the Association of German Engineers (VDI). The VDI 4707-1 standard classes range from “A” to “G”, with class “A” being the most energy efficient class. The given result is based on measurements and valid for a Schindler 3300 in VDI usage category 1 with a load of 675 kg, a travel height of 17m, a speed of 1,0 m/s and with optional energy-saving features (e.g. Recuperating Frequency Converter (PF1)). The VDI classification and energy consumption of individual installations may deviate from this result, e.g. due to different or additional customer options and/or different configuration.

Choice of design

The Schindler 3300 elevator unifies design and functionality in a way that makes passengers feel comfortable and safe. Combine style, colors and options to suit your building. Carefully selected materials enhance the look and feel.



2 style sets

Choose Round for a smooth organic appearance, or Square for a modern linear look. The style sets are expressed through the ceiling, corners and handrail design.

4 design lines

From fresh and lively to warm and inviting, choose the wall and floor color you want from our three distinct décor lines. When it comes to customizing your elevator car interior, our Libertà design line sets you free.

41 colors

From fresh and lively to warm and inviting, choose the wall and floor color you want from our three distinct décor lines.

A great look always comes in style

Car interior style sets

Make a statement

When deciding on an ambiance for your elevator car, start with the basics: Round or Square? Then choose wall and floor colors from our three décor lines, all manufactured from high-quality materials. Add details like matching operating panels, mirrors and handrails to bring the style to life.

Round style set

Create a smooth and organic feeling. The Round interior style set comes with:

1. Bracket or Curve ceiling
2. Rounded handrail as option
3. Curved corners

Square style set

Convey modern functionality with a minimalist and clean interior décor. The Square interior style set comes with:

1. Line or Spot ceiling
2. Straight handrail as option
3. Corner less car

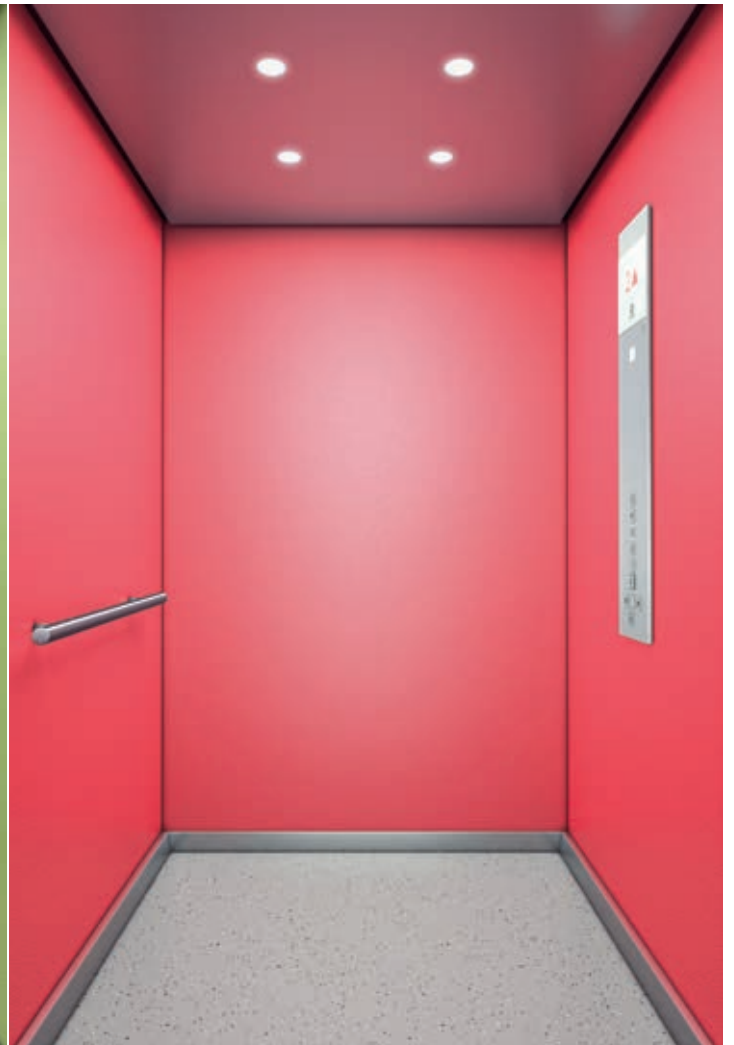

Santa Cruz

Colorful and versatile

Lighting
LED Line

Piccadilly

Vibrant and sophisticated

Lighting
LED Spot

Esplanade

Contemporary and durable

Lighting
LED Curve

Libertà

Personalize your elevator

Lighting
LED Bracket

Santa Cruz

Colorful and versatile

Walls unicolor/bicolor

Laminate Mascara Red	Laminate Bologna Orange	Laminate Tangier Orange	Laminate Aswan Yellow
Laminate Palermo Purple	Laminate Capri Lemon	Laminate Suez Grey	Laminate Siena Brown
Laminate Cadiz Blue	Laminate Tahiti Green	Laminate Granada Metallic Platinum	Laminate Maribor Metallic Silver
Laminate Athens Grey	Laminate Milan Grey	Laminate Catania Light Grey*	

Ceiling **Corner** **Skirting**

Ceiling** Riga Grey	Ceiling Stainless steel Lugano Matt Finish	Corner Aluminum Polished	Corner Aluminum Anodized	Skirting Stainless steel Brushed	Skirting Aluminum Anodized
-------------------------------	---	---------------------------------------	---------------------------------------	---	---

Floor

Rubber speckled Black	Rubber speckled Sand	Rubber speckled Light Grey	Rubber speckled Anthracite	Prepared for customer-supplied floor
---------------------------------	--------------------------------	--------------------------------------	--------------------------------------	--------------------------------------

Car door and front

Painted Riga Grey	Stainless steel Lucerne Brushed	Stainless steel Lausanne Linen
-----------------------------	---	--

* Rear wall only
** Riga Grey with Bracket ceiling only

Specifications, options and colors are subject to change.
All cars and options illustrated in this brochure are representative only.
The samples shown may vary from the original in color and material.



Santa Cruz

Santa Cruz offers a variety of upbeat and visually striking colors, from bright and breezy to warm and welcoming. Choose one color for the entire car interior or vary the color of the rear wall for contrast – an option exclusive to this line.

- Style set:** Square
- Ceiling:** Line, Stainless steel Lugano Matt Finish
- Walls:** Cadiz Blue
- Handrail:** Straight, Stainless steel Brushed
- Skirting:** Aluminum Anodized
- Floor:** Rubber speckled Light Grey

Piccadilly

Vibrant and sophisticated

Walls unicolor

Laminate Petersburg Amber	Laminate Toronto Titanium	Laminate Vancouver Wood	Laminate Slavonia Wood
Laminate Leon Silver	Laminate Kashmir Blue	Laminate Chicago Wood	Laminate Arosa Wood
Laminate Birmingham Anthracite	Laminate Stockholm Grey		
Laminate Oxford Blue	Laminate Santorini White		

Ceiling

Corner

Skirting

Ceiling* Riga Grey	Ceiling Stainless steel Lugano Matt Finish	Corner Aluminum Polished	Corner Aluminum Anodized	Skirting Stainless steel Brushed	Skirting Aluminum Anodized
------------------------------	---	------------------------------------	------------------------------------	--	--------------------------------------

Floor

Rubber speckled Black	Rubber speckled Sand	Rubber speckled Light Grey	Rubber speckled Anthracite	Prepared for customer-supplied floor
Artificial granite Black	Artificial granite Grey	Artificial granite Light Brown	Artificial granite Sand	

Car door and front

Painted Riga Grey	Stainless steel Lucerne Brushed	Stainless steel Lausanne Linen
-----------------------------	---	--

* Riga Grey with Bracket ceiling only



Piccadilly

Perfect for professional settings, this line's combinations of autumnal Northern hues and naturalistic wood laminates express everyday sophistication. The color laminates create a glossy effect and lend the car a distinguished feel, while the wood laminates evoke harmony and modernism.

Style set: Square
Ceiling: Spot, Stainless steel Lugano Matt Finish
Walls: Santorini White
Handrail: Straight, Stainless steel Brushed
Skirting: Aluminum Anodized
Floor: Rubber speckled Anthracite

Esplanade

Contemporary and durable

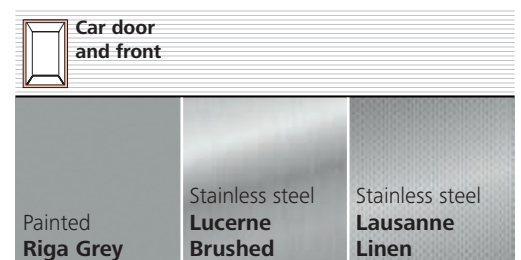
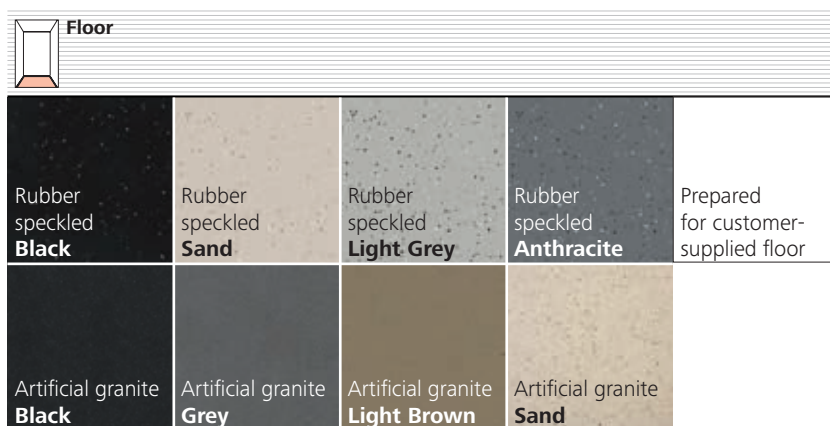
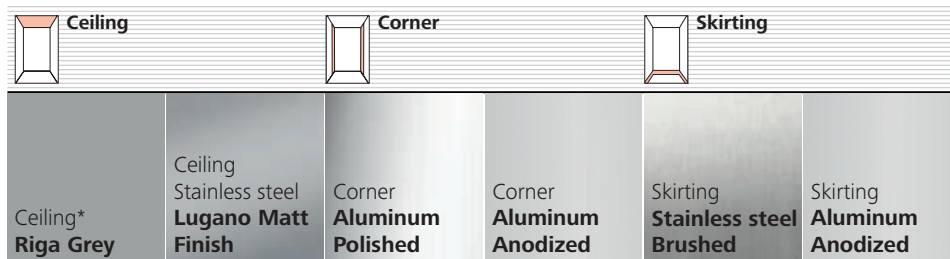

* Riga Grey with Bracket ceiling only

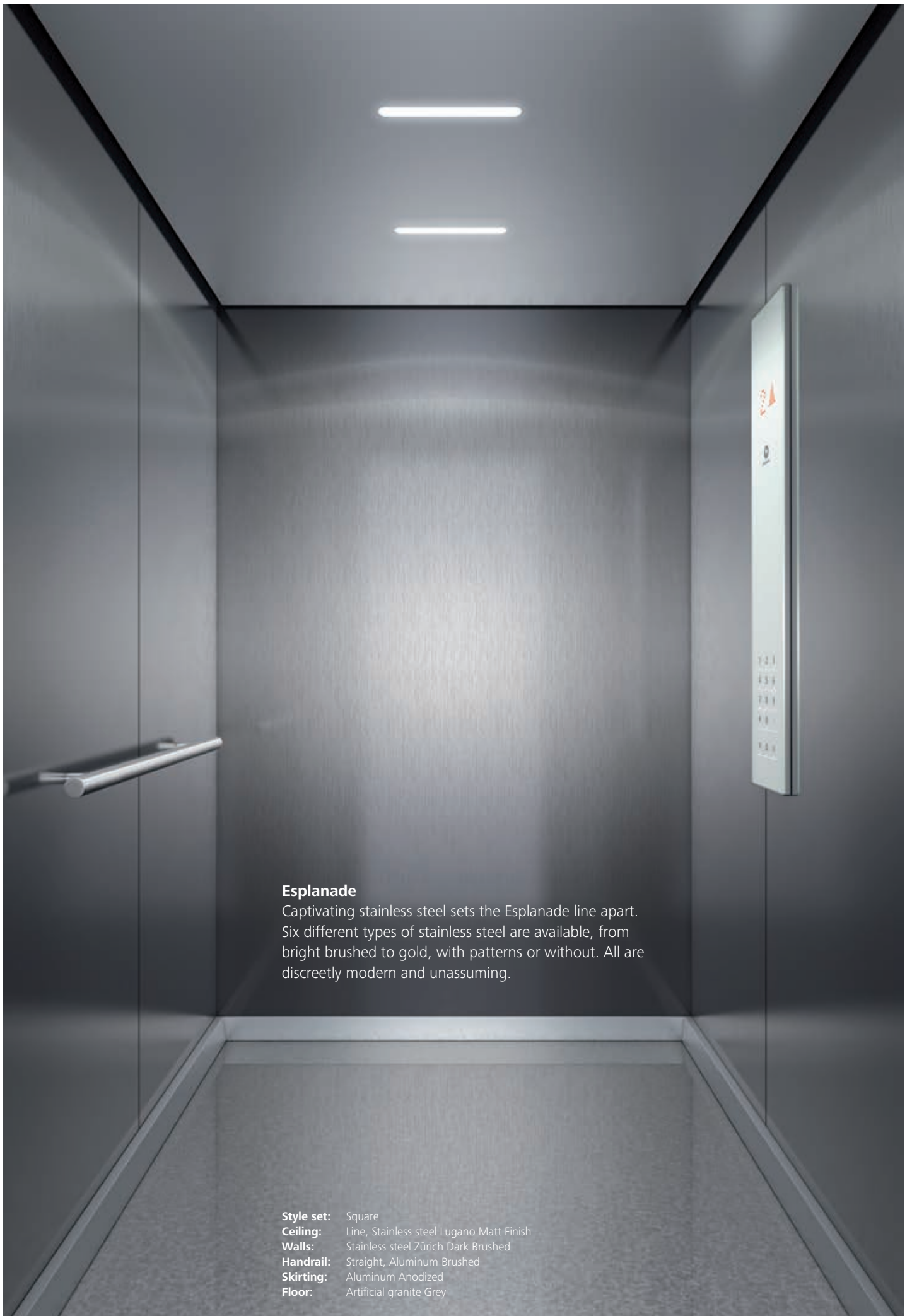

Esplanade

Captivating stainless steel sets the Esplanade line apart. Six different types of stainless steel are available, from bright brushed to gold, with patterns or without. All are discreetly modern and unassuming.

Style set: Square
Ceiling: Line, Stainless steel Lugano Matt Finish
Walls: Stainless steel Zürich Dark Brushed
Handrail: Straight, Aluminum Brushed
Skirting: Aluminum Anodized
Floor: Artificial granite Grey

Libertà – Personalize your elevator



Do you want to put yourself in the design director's chair?

With the Libertà option, enjoy the possibility to create your own car interior with a free choice of combinations. Select the ceiling, combine any wall and floor colors from our 3 distinct décor lines and choose your options.

Ceilings

Round or square

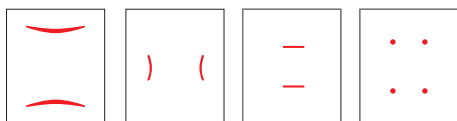

Handrails

Straight, straight with curved ends or curve & placement

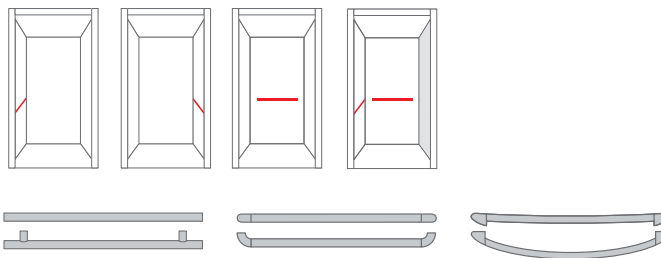

Mirror

Full or half height & placement

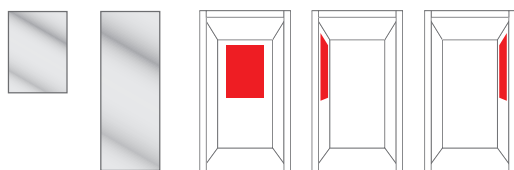

Glass Rear Wall

Full or half height

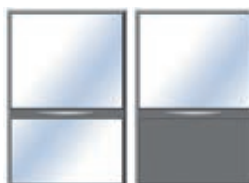

Corners 2 Finishings

Corner
Aluminum Anodized

Skirtings 4 Finishings

Skirting
Aluminum Anodized

Floors 8 Colors

Floor
Artificial granite Grey

Walls 33 Colors

Wall
Laminate Mascara Red

Rear Wall
Glass

Rear Wall
**Brushed steel
Doha Gold**

Car Door & Front 3 Finishings

Car door & front
Lausanne Linen

Lighting 4 Styles

Lighting
Spot

Handrails 3 Shapes 3 Finishings

Handrail straight
Stainless steel Brushed

Ceilings 2 Finishings

Ceiling
**Stainless steel Lugano
Matt**

New Flex Edition

Outstanding flexibility: Schindler 3300 offers you the largest flexibility in car and shaft dimensions. With this option the elevator adapts with millimeter accuracy to your building.

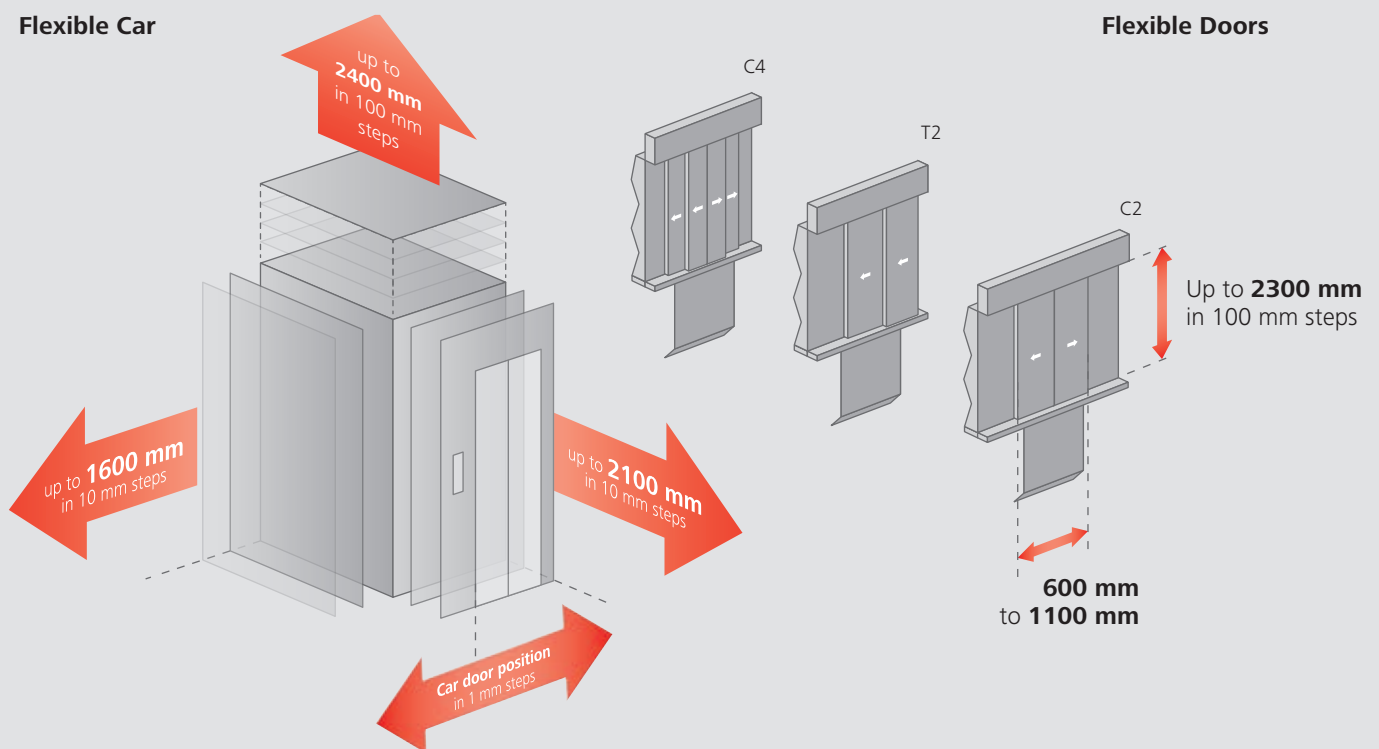

Flexible Car Dimensions

The Schindler 3300 concept ensures more space for your passengers – even in small shafts. Car dimensions are adjustable in 10 mm increments – to guarantee optimal use of space. The car width ranges from 760 mm up to 1600 mm and the car depth can be selected between 900 mm and 2100 mm. Car height can be increased up to 2400 mm. This flexibility makes the Schindler 3300 your choice to reach your building requirements.

Flexible Door Dimensions

Thanks to the flexible door system the position of the door can be placed with millimeter accuracy. The door width is adjustable in 50 mm steps and offers a height between 2000 mm and 2300 mm. Variable door opening mechanisms such as telescopic door (T2) and center opening doors (C2, C4) are available. Choose between single or two-sided entrance (through-loading).



Higher Doors – up to 2300 mm
Wider Doors – 600 mm to 1100 mm



Higher Cars – up to 2400 mm



Additional weight allowance for local cladding – up to 300 kg



Thicker car floors – up to 40 mm



Longer car operating panels –
Full car height

The new flex edition is designed to fit your commercial demands

Higher doors and cars with wider entrances have been introduced to match high entrance halls, complementing the commercial look and feel of your building. The interior design is fully customizable allowing you to tailor your elevator car creating a superior customer experience.



Stainless steel panel line

Characteristics and options

Operating Panels

Our sleek and wear-resistant combination of stainless steel and glass is equipped with mechanical push buttons. The line consists of car operating panels and landing operating panels as default elements. For clear navigation throughout your building, indicators and nameplates can be supplied.

Keypad

The keypad features a conventional layout. Each floor is listed separately, ideal for low-rise buildings. Buttons will be arranged in single, double or triple columns, depending on the number of floors.



Horizontal car operating panel
500 × 192 mm

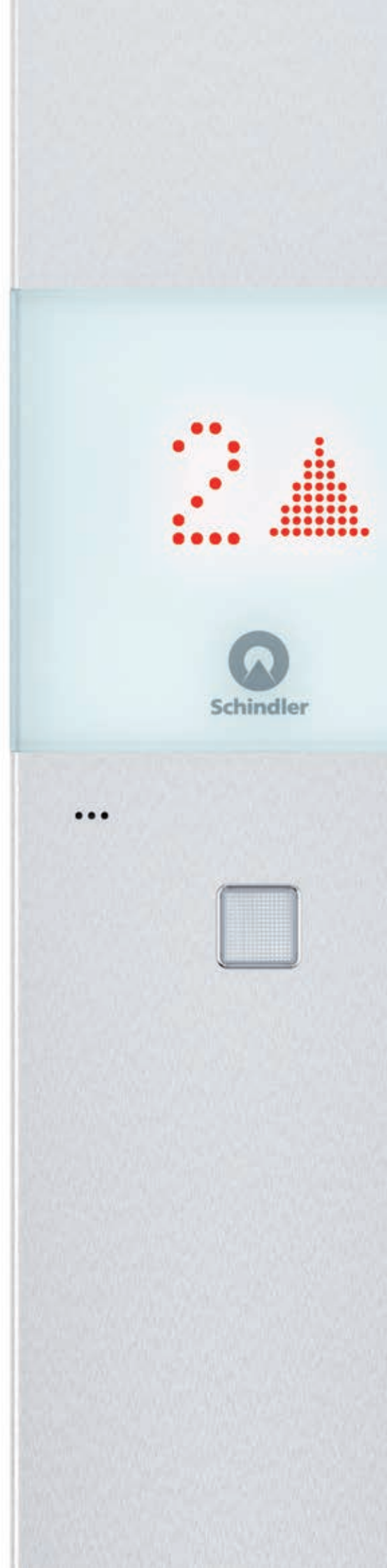

Car operating panel

- 1 **Nameplate**
82 × 1051 mm
- 2 **Car operating panel**
197 × 1052 mm
- 3 **Car operating panel**
with integrated key switch
197 × 1052 mm
- 4 **Car operating panel**
with key switch
197 × 1176 mm
- 5 **Full height car operating panel**
197 × 2031 mm



Landing panels

- 6 **Landing indicating panel**
65 × 290 mm
- 7 **Landing operating panel**
65 × 160 mm
- 8 **Landing operating panel**
with key switch
65 × 225 mm

Key switch

- 9 Layout for panels with
mechanical buttons
197 × 136 mm



Glass panel line

Characteristics and options

Operating Panels

Our stylish and modern glass panel line is equipped with a touch-sensitive keypad. The line consists of car operating panels and landing operating panels as default elements. For clear navigation throughout your building, indicators and nameplates can be supplied.

Keypads

The glass panel line features two keypad versions for car operating panels. A ten digit layout, allowing passengers to compose the desired floor number (like a phone); and a conventional layout listing each floor (best suited for low-rise buildings). Buttons are arranged in triple columns.



Car operating panel

- 1 **Car operating panel (10 digit)**
210 × 1051 mm
- 2 **Car operating panel (conventional keypad)**
With key switch
210 × 1171 mm
- 3 **Nameplate**
82 × 1051 mm



Landing panels

- 4 **Landing operating panel**
65 × 160 mm
- 5 **Landing operating panel with key switch**
65 × 225 mm
- 6 **Landing indicating panel**
65 × 290 mm

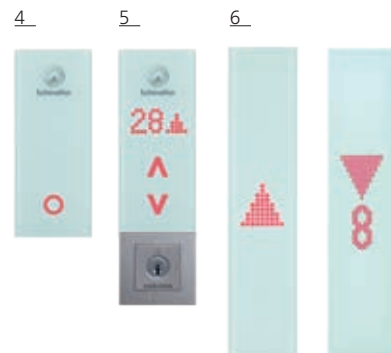

Key switch

- 7 **Layout for panels with touch-sensitive buttons**
210 × 120 mm



Mounting options

Position and type of installation



Surface mount
For classic designs



For car operating panels ①
on car wall

For landing operating panels ② and indicators ③
on door frame or wall

Flush mount
For a modern,
minimalistic look



For landing operating panels ② and indicators ③
on door frame or wall

Selected features and options

Performance

Group operation up to three elevators	▲
One-sided entrance	■
Two-sided entrance	▲
Selective door opening	▲
Pre-opening of doors	▲
Extended door opening time (adjustable)	■
Telescopic opening doors (T2)	■
Center opening doors (C2, C4)	▲
Overload detection and visualization in car	■
Two-way communication with assistance center (Telealarm)	■
Embedded Tele Monitoring Alarm (ETMA)	■
Automatic car re-leveling	■
Automatic return of car to main floor	▲
Manual evacuation to nearest floor	■
Automatic evacuation to nearest floor	▲
Certified pit ladder	■
Wireless Communication Gateway	▲
Remote monitoring and diagnostics	▲
Automatic non-stop operation	▲
Car ventilator	▲
Floor lighting control	▲
Building management interface	▲
Safety gear on counterweight for 1m/s	▲
Control integrated in door frame	■

Design

Rounded and Square interior style sets	■
Four ceilings with LED lighting	■
Three décor lines (Santa Cruz, Piccadilly and Esplanade)	■
Libertà concept: flexible interior design	▲
Flex concept: flexible car adjustment in 10 mm and door in 50 mm steps, Flexible door placement	●
Car height up to 2400	●
Door height up to 2300	●
Prepared for customer-supplied floor < 13 mm	■
Prepared for customer-supplied floor < 40 mm	●
Prepared for customer-supplied walls and ceiling	●
Additional weight allowance for local decoration	●
Mirror, full-height, 600 mm width	▲
Mirror, half-height, 600 mm or 900 mm width	▲
Nameplate for glass COP	▲
Nameplate for stainless steel COP	▲
LOP and LIP surface or flush mounted on door frame or wall	■
Round handrail aluminum Riga Grey, Polished or Brushed	▲
Straight handrail stainless steel Riga Grey, Polished or Brushed	▲
Straight handrail with curved ends stainless steel Riga Grey, Polished or Brushed	▲
Skirting round stainless steel brushed or aluminum anodized	■
Skirting straight stainless steel brushed or aluminum anodized	▲
Car door stainless steel Riga Grey, Brushed or Linen	■
Landing door stainless steel Painted (RAL 7032)	■
Landing door Stainless steel Lucerne Brushed	▲
Landing door Stainless steel Lausanne Linen	▲
Landing and Car glass door	●
Glass rear wall: half height	▲
Glass rear wall: full height	▲
Low headroom	▲
Low pit	▲

Accessibility

Control options

Pick-up collective (PI), single call travel w/ call registration	■
Down-collective (KA), calls collected unidirectional	▲
Collective-selective control (KS), calls collected bidirectional	▲

Car operating Panels (COP)

Glass, touch-sensitive, 10 button keypad layout (0-9)	▲
Glass, touch-sensitive, conventional keypad layout with floor designation (-3 to 23)	▲
Stainless steel, mechanical push buttons, conventional keypad layout up to 23 floors (-3 to 20)	■
Stainless steel, mechanical push buttons, 10 button keypad layout (0-9)	▲
Full height COP with mechanical push buttons	●
Horizontal COP with mechanical push buttons (EN81-70 compliant)	▲
Second, vertical COP opposite to main car operating panel	▲
Braille on mechanical push buttons	▲
Door open/close and alarm button	■
Position indicator	■
Visual destination floor display for KS	▲
Visual direction indicator (arrow)	■
Visual floor destination indicator (number) for KS	▲
Audible floor announcement	▲
Key switch	▲
Car emergency light	■
Induction loop for hearing devices	▲

Landing operating panels

Glass, touch-sensitive	▲
Stainless steel, mechanical push button	■
Visual call acceptance	■
Audible call acceptance	■
Visual direction indicator (arrows)	▲
Visual car position indicator (number)	▲
Key switch	▲
Door frame mounted	■
Wall mounted	▲
Braille on mechanical push buttons	▲
Light curtain protection on doors	■
EN 81-70 compliance kit	▲

Security

Emergency power operation	▲
Reservation and restricted access to floors:	
via key switch	▲
via key card	▲
via Pin Code (Glass COP 10 key pad)	▲
Car call-by-key for parking floors	▲
Automatic return to main from parking floors	▲
Penthouse: visitor pick-up control	▲
Fireman's control BR1 (EN81-73) w/ interface to fire protection system	▲
Alarm horn in car or in shaft	■

Green

Regenerative PF 1 drive	▲
Standby mode	■
Automatic car light switch (on/off)	■
Energy saving LED lighting	■
VOC free (Volatile Organic Compound)	■
Lubrication free gearless drive	■

■ Standard ▲ Option ● Flex



Ceiling Line, Stainless steel Lugano Matt Finish



Ceiling Bracket, Stainless steel Lugano Matt Finish

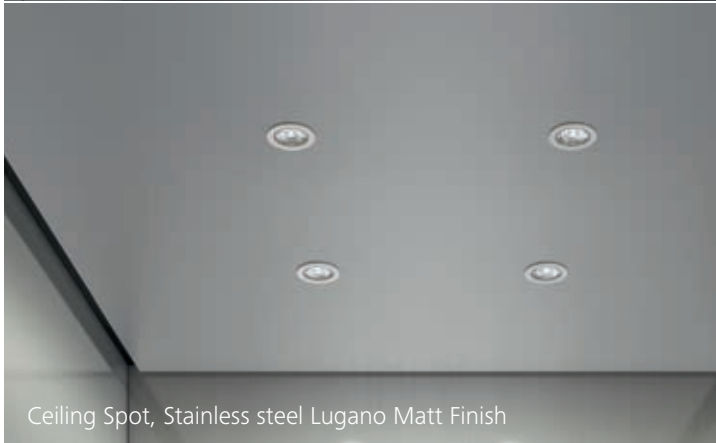

Ceiling Spot, Stainless steel Lugano Matt Finish



Ceiling Curve, Stainless steel Lugano Matt Finish



Glass doors



Glass rear wall

Corner, Aluminum Polished



Corner, Aluminum Anodized



Handrail rounded, Aluminum Riga Grey



Handrail straight, Stainless steel Polished

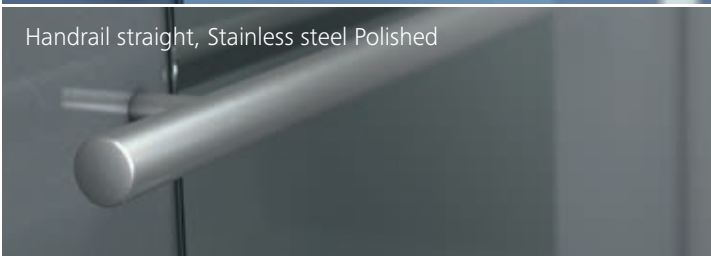

Handrail straight curved ends, stainless steel brushed

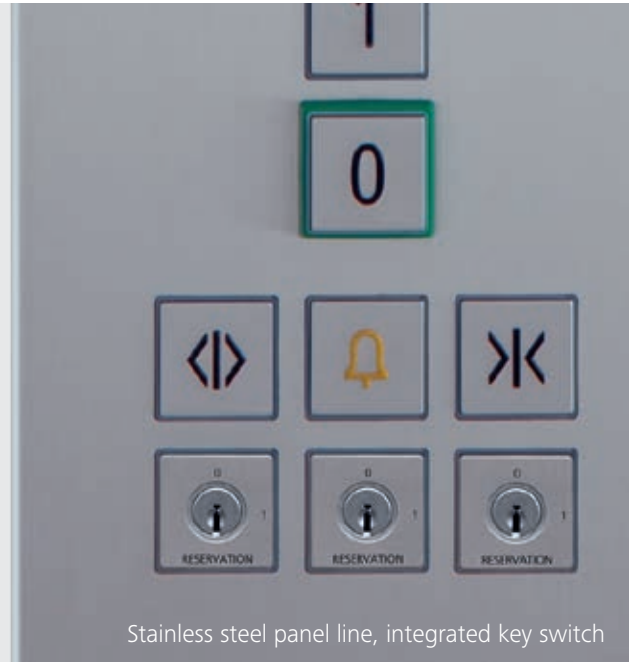
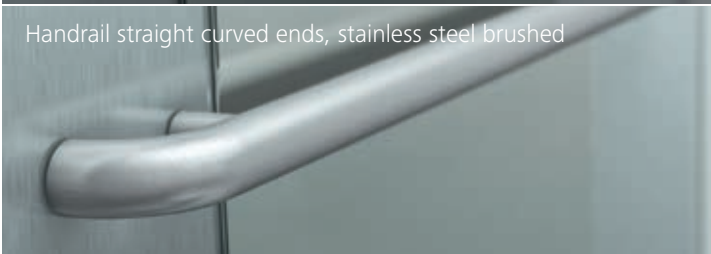

Stainless steel panel line, integrated key switch



Key switch for glass car operating panel



Skirting straight, stainless steel brushed

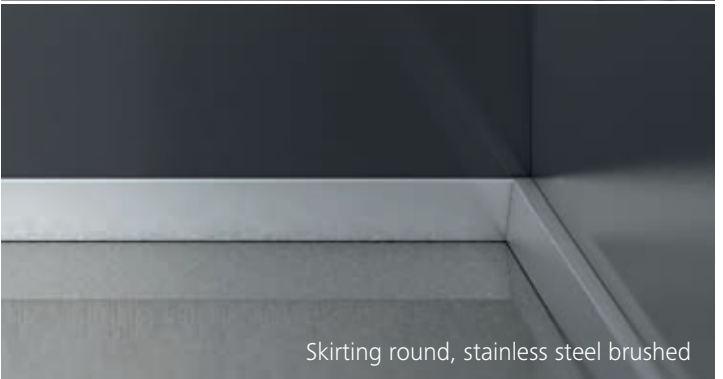

Skirting round, stainless steel brushed

Planning Data

All elevators placed on the market as of 1st September 2017 must comply with EN 81-20**. Please contact us for any further questions.

Specifications Schindler 3300*

Machine room-less traction elevator with frequency-controlled drive Capacity 400–1125 kg, 5–15 passengers

GQ kg	Persons	VKN mzs	HQ m	ZE	Entrance	Car			Doors			Shaft					
						BK mm	TK mm	HK mm	Type	BT mm	HT mm	BS mm	TS ⁽¹⁾ mm	TS ⁽²⁾ mm	HSG mm	HSK ⁽¹⁾ mm	HSK ⁽²⁾ mm
400	5	1.0	45	15	1	1000	1100	2135	T2	750	2000	1400	1450	—	1060	3400	2900
535	7	1.0	45	15	1, 2	1050	1250	2135	T2	800	2000/2100	1500	1600	1800	1060	3400	2900
							1300						1650	1850			
		1.6	66	20	1, 2	1050	1250	2135	T2	800	2000/2100	1500	1600	1800	1250	3600	—
							1300						1650	1850			
625	8	1.0	45	15	1, 2	1200	1250	2135	T2	900	2000/2100	1600	1600	1800	1060	3400	2900
							1300						1650	1850			
		1.6	66	20	1, 2	1200	1250	2135	T2	900	2000/2100	1600	1600	1800	1250	3600	—
							1300						1650	1850			
675	9	1.0	45	15	1, 2	1200	1400	2135	T2	800	2000/2100	1600	1750	1950	1060	3400	2900
										900	2000/2100					3400	2900
									C2	800	2000/2100	1800	1700	1800	1060	3400	2900
										900	2000/2100	2000					
		1.6	66	20	1, 2	1200	1400	2135	T2	800	2000/2100	1600	1750	1950	1250	3600	—
										900	2000/2100						
									C2	800	2000/2100	1800	1700	1800	1250	3600	—
										900	2000/2100	2000					
800	10	1.0	45	15	1, 2	1400	1400	2135	C2	800	2000/2100	1800	1700	1800	1060	3400	2900
										900		2000					
		1.6	75	20	1, 2	1400	1400	2135	C2	800	2000/2100	1800	1700	1800	1250	3850	—
										900		2000					
900	11	1.0	45	15	1, 2	1400	1500	2135	C2	900	2000/2100	2000	1800	1900	1060	3400	2900
		1.6	75	20	1, 2	1400	1500	2135	C2	900	2000/2100	2000	1800	1900	1250	3850	—
1000	13	1.0	45	15	1, 2	1600	1400	2135	C2	900	2000/2100	2000	1700	1800	1060	3400	2900
		1.6	75	20	1, 2	1600	1400	2135	C2	900	2000/2100	2000	1700	1800	1250	3850	—
1125	15	1.0	45	15	1, 2	1200	2100	2135	T2	900	2000/2100	1650	2450	2650	1060	3400	2900
		1.6	60	20	1, 2	1200	2100	2135	T2	900	2000/2100	1650	2450	2650	1250	3600	—

GQ Capacity
VKN Speed
HQ Travel height
ZE Stops
HE Interfloor distance

BK Car width
TK Car depth
HK Car height

T2 Telescopic door, 2-part
C2 Center opening door, 2 part
BT Door width
HT Door height

BS Shaft width
TS⁽¹⁾ Shaft depth 1 entrance
TS⁽²⁾ Shaft depth 2 entrances
HSG Pit depth
HSK⁽¹⁾ Headroom height for safety gear on counterweight HSK min. + 70 mm
HSK⁽²⁾ Optional (depending on local code)

Interfloor distance (HE) is:
 min. 2400 mm for door height 2000 mm / min. 2500 mm for door height 2100 mm
 HE for two-stop installations is min. 2600 mm for door height 2000 mm and 2100 mm.
 The short interfloor distance (HE min.) for opposite entrances is 300 mm.

**EU type examination in accordance with Lifts Directive (Directive 2014/33/EU), based on EN 81-20

* For flexible car option, please contact your Schindler consultant.

Height and layout

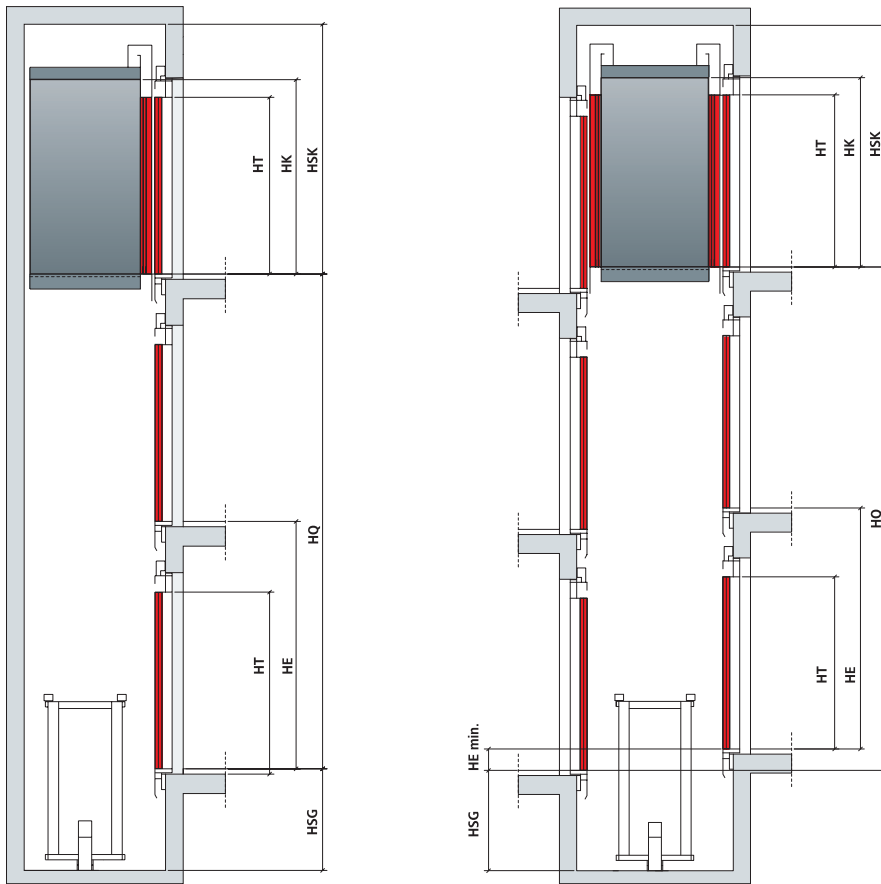

One-sided entrance

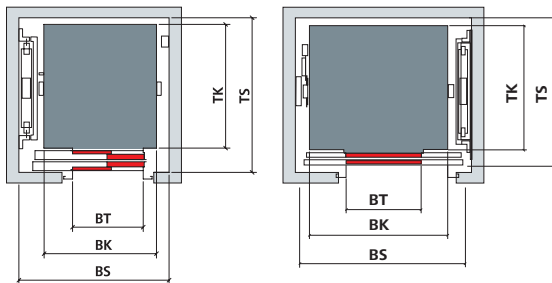

Two-sided entrance

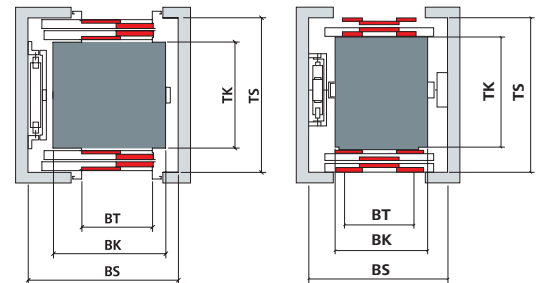

Frame

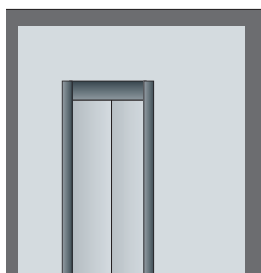

Full front

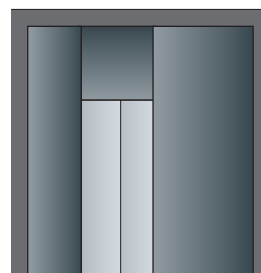

From the subway to the skyline.

Providing urban mobility.

Mobility is an essential requirement in the world in which we live and work. Schindler stands for urban mobility and is recognized as a hallmark of quality and safety. Daily, one billion people worldwide place their trust in Schindler products and services.

Schindler provides urban mobility with elevators, escalators and services that are engineered for efficiency and sustainability. Schindler accompanies the development of buildings from planning and construction to daily operation, thus safeguarding their lifetime value.

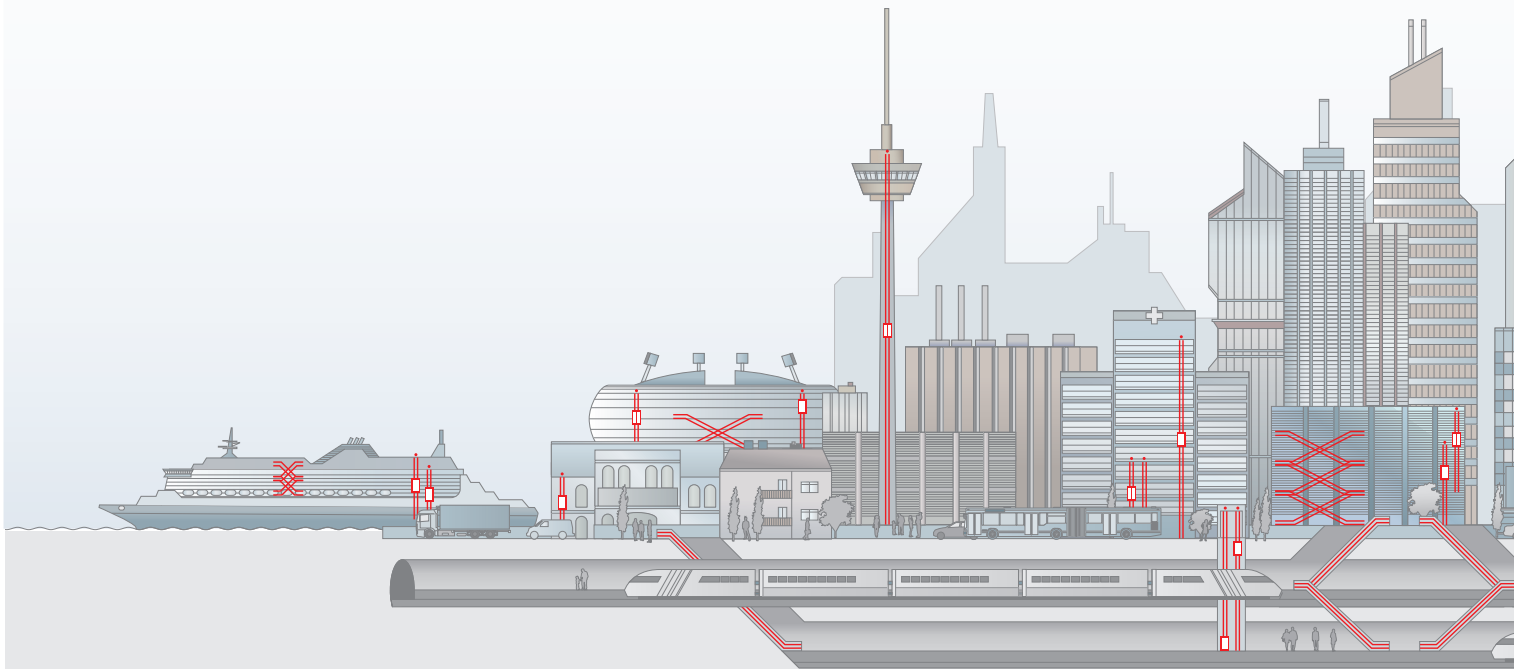

Ingenious planning

Selecting the right mobility solution means to analyze the building requirements and to calculate the potential traffic patterns. This is at the core of Schindler's planning support to ensure efficient mobility and a convenient journey for passengers. Bringing together global know-how for each individual project.

Schindler planning services:

- Expert consultants for traffic and product planning
- Traffic analysis and calculation service
- Specialized engineering centers for customized configurations
- Planning guidelines and tools to expedite shaft planning, building layout and product selection/configuration

Seamless delivery

With a full-range portfolio of elevators and escalators, Schindler provides mobility solutions for any building application. Schindler customers can rely on sustainable technology, excellent project management and profound installation methodologies. It's always the perfect fit.

Technology for all building types and mobility needs:

- Residential and office buildings
- Commercial towers, retail environments
- Hospitals and public buildings
- Heavy-traffic environments
- High-rise buildings
- Cruise liners



Efficient operation

Smooth, hassle-free operation and very high availability are the result of professional maintenance and modernization. Environmental and operational efficiency add value to the investment. Reliability and sustainability – every day, all day.

- The maintenance, repair and modernization portfolio:
- Global network of branches and service points
 - Skilled and certified technicians and fitters
 - Service solutions for all building types and requirements
 - Availability and fast delivery of spare parts
 - Quick responding call-center services
 - E-monitoring diagnostic tools
 - Replacement and step-by-step modernization solutions

Continuous enhancement

Schindler constantly develops new products and features to set standards and increase efficiency. Technological milestones that provide mobility to the urban society – conveniently, safely and ecologically. Progress needs innovation.

- The cutting-edge developments:
- PORT Technology – traffic, building communication and access-control management that calculates the swiftest route in the building
 - Schindler regenerative PF1 clean drive technology
 - Space-saving, weight-optimized designs
 - Flexible modernization concepts from full replacements to partial retrofits
 - Eco-mode options for escalators and elevators

When vision meets discipline. Schindler partners with Solar Impulse.



Schindler is a main partner of **Solar Impulse**, the zero fuel airplane aiming to fly around the world propelled only by solar energy.

This publication is for general informational purposes only and we reserve the right at any time to alter the product design and specifications. No statement contained in this publication shall be construed as a warranty or condition, expressed or implied, as to any product, its fitness for any particular purpose, merchantability, quality or shall be interpreted as a term or condition of any agreement regarding the products or services contained in this publication. Minor differences between printed and actual colors may exist.