



Schindler 9500AE Inclined Moving Walks
Reliable and efficient. Elegant look.
Ideal for commercial buildings.



With your needs in mind Schindler 9500AE inclined moving walks

▶▶▶ Your safety, our responsibility

The Schindler 9500AE inclined moving walk is designed to meet the highest standards in the industry. We ensure that each passenger enjoys a safe ride.

▶▶▶ Energy efficient, eco-friendly

Integrated with our latest energy-saving technology: premium drive efficiency, smart power management at times of low passenger density and selected low-power components, the Schindler 9500AE inclined moving walk is one of the most efficient moving walks in retail applications.

▶▶▶ Superb quality, global service

Thanks to its high-grade, low-wear-and-tear components, the Schindler 9500AE inclined moving walk is a product with superb quality and performance. Wherever you are, Schindler global services protect your long-term investment.

▶▶▶ Elegant adaptable design options

The Schindler 9500AE inclined moving walk offers you not only timeless basic equipment but also highly distinctive customized design options, which make it easily adaptable to smaller commercial areas and high-end shopping centers.

Your safety, our responsibility

At Schindler, safety comes first. This has been our company's motto over 100 years – and it always will be! Schindler cares about every single passenger: With the highest standards in the industry we ensure each passenger enjoys a safe ride.

From system-related safety solutions ...

MICONIC F – intelligent

microprocessor controller: Two independent safety circuits control each safety device in real time. Double check means double safety. A unique safety feature from Schindler.

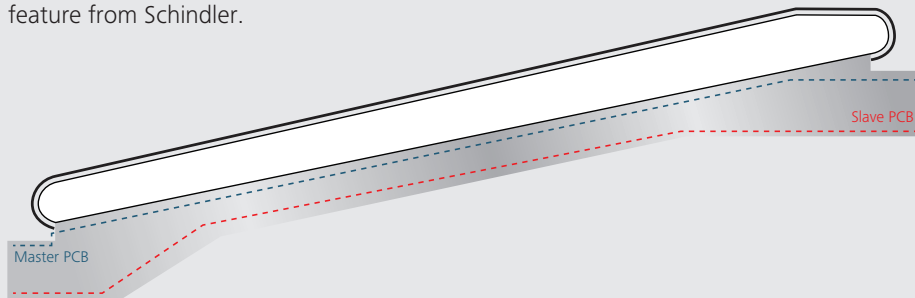

Did you know that Schindler is the only company in the industry that produces moving walk pallets in-house? All pallets have to pass the regulatory static breaking load test as well as the eccentric breaking load test above the roller pin before they leave the factory, which exceeds EN 115-1 requirements.

... to human-centered design ...

Maximum safety against shoe wedging: Schindler's unique safety feature

The pallets' sides run underneath the skirt panels, eliminating the horizontal side gap found in conventional products, making the Schindler design 25 times safer with respect to pinching and wedging than conventional moving walk designs.

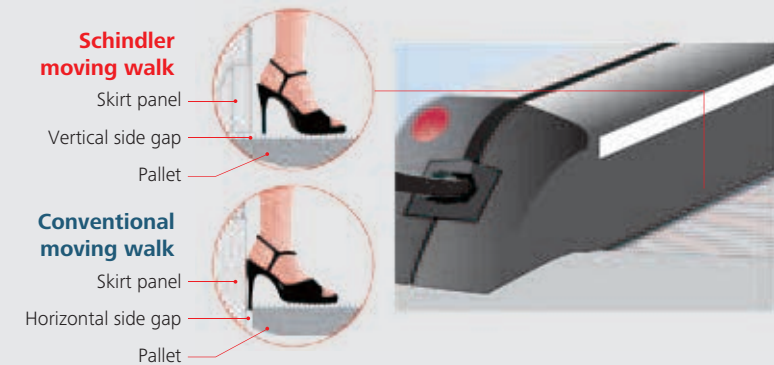

Unrestricted access for shopping carts

Shopping carts can be effortlessly rolled on and off the unit since the combs are extremely flat, with an inclination of only 11 degrees.

... to the most comprehensive safety package in the industry.

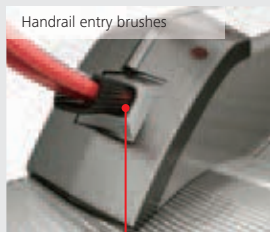

Handrail entry brushes

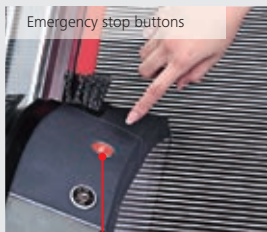

Emergency stop buttons



Pallet gap lighting



2nd emergency stop button



Would you like more information on safety?
Please consult the Schindler escalator safety
brochure: State of the Art.

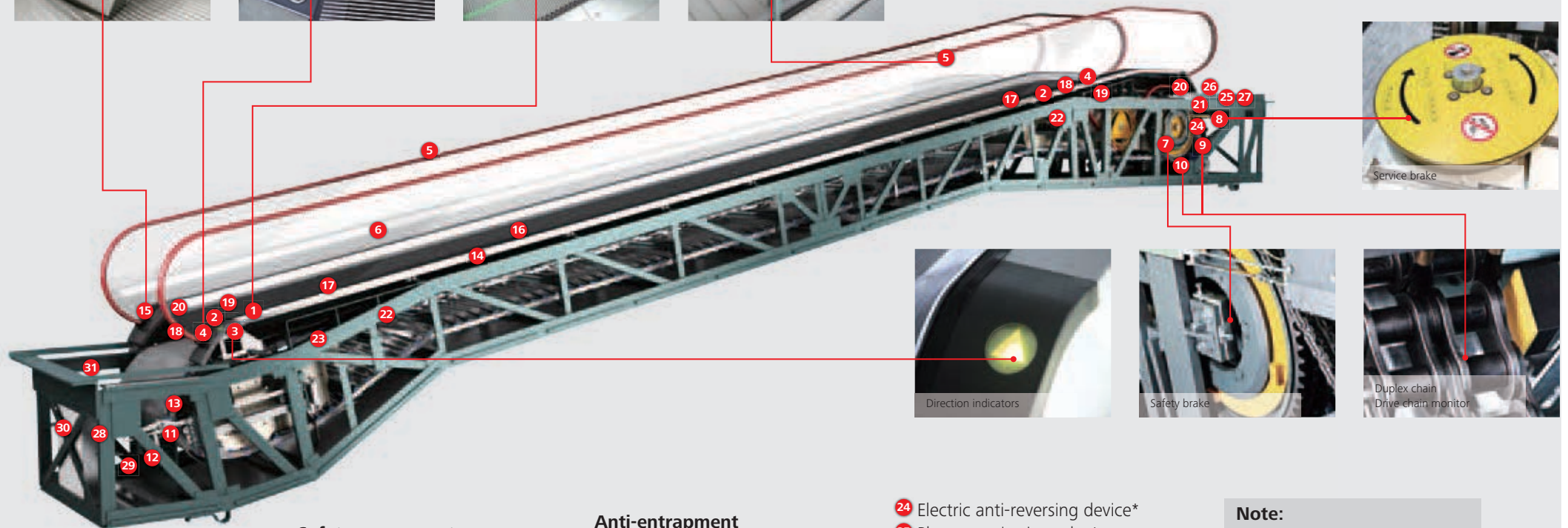

Service brake



Direction indicators

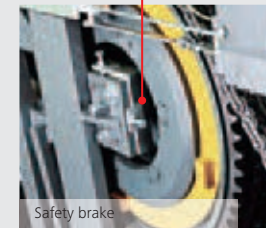

Safety brake

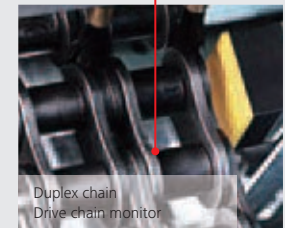

Duplex chain
Drive chain monitor

Safety indicators

- 1 Pallet gap lighting
- 2 Complate lighting
- 3 Direction indicators
- 4 Emergency stop button*
- 5 2nd emergency stop button

Safety components

- 6 Guards against climbing the balustrade
- 7 Safety brake on drive shaft
- 8 Service brake*
- 9 Duplex chain*
- 10 Drive chain monitor
- 11 Pallet chain tension contacts*
- 12 Guard plates*
- 13 Countertrack*
- 14 Grip+ pallet

Anti-entrapment

- 15 Handrail entry brushes*
- 16 Skirt brushes*
- 17 Pallet level contact*
- 18 Complate contacts*
- 19 Skirt contacts
- 20 Handrail entry contacts*

Anti-reversal

- 21 Speed monitor*
- 22 Pallet monitor*
- 23 Handrail monitor*

- 24 Electric anti-reversing device*

- 25 Phase monitoring relay*

Additional safety features

- 26 Motor protection*
- 27 Brake lining monitor
- 28 Fire contact
- 29 Smoke detector
- 30 Water level contact
- 31 Floor cover contact*

Note:

The list not only includes all safety features required by national safety standards as basic configuration, but specifies even more optional extras.

* Schindler standard items.

Energy-efficient, eco-friendly

The Schindler 9500AE inclined moving walk features three design solutions that increase energy efficiency: more efficient drive systems, components requiring less power, and intelligent power management software. We call it the Schindler E³ energy-saving approach.

E³ – Schindler's unique energy-saving approach

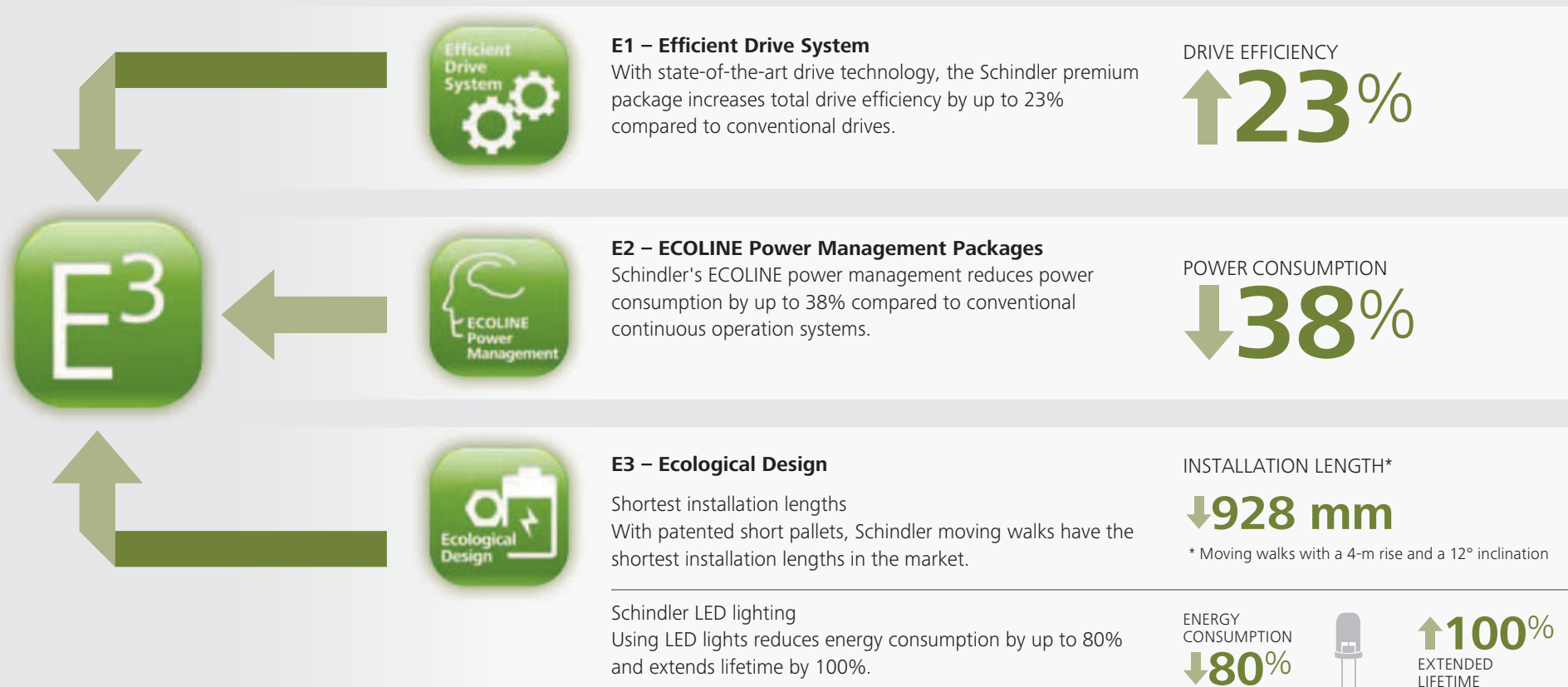



Would you like more information on efficiency? Please consult the Schindler escalator efficiency brochure: Performance is not a question of consumption.

Choose your ECOLINE package*:

ECOLINE	ECO Plus 	ECO Premium 	ECO Premium Plus 
Energy consumption [▲]	-6,340 kWh -38% 	-5,662 kWh -34% 	-6,204 kWh -37% 
Operating mode	Stop-&-go operation with ECO power feature: Moving walk stops when no passengers are on it	Slow-speed operation with ECO power feature: Moving walk slows down when no passengers are on it	Stop-and-go and slow-speed operation with ECO power feature: Moving walk stops after an adjustable time running in slow speed.
Application	Intermittent flow including periods of zero passenger flow	Intermittent flow including periods of zero passenger flow	Intermittent flow including periods of zero passenger flow
Benefits	<ul style="list-style-type: none"> • Power consumption reduced by up to 36% • Reduced power plant CO₂ emissions • Increased moving walk lifespan 	<ul style="list-style-type: none"> • Passenger flow maintained, as moving walk is in motion when passengers are approaching it • Power consumption reduced by up to 32% • Reduced power plant CO₂ emissions • Reduced wear & tear on components 	<ul style="list-style-type: none"> • Passenger flow maintained, as moving walk is in motion when passengers are approaching it • Power consumption reduced by up to 35% • Reduced power plant CO₂ emissions • Reduced wear & tear on components • Increased moving walk lifespan
CO ₂ footprint	Minus 9,510 kg per year	Minus 8,500 kg per year	Minus 9,300 kg per year
Amortization*	Less than 1.5 years	Less than 2 years	Less than 2 years

*) Values based on theoretical calculations for one Schindler 9500AE inclined moving walk. Average value for up and down operated moving walk pair: 4.5 m. pallet width: 1000 mm. Speed: 0.5 m/s. Load profile: 11 hours per day, 365 days per year. 2.5 hrs – 0%. 7 hrs – 25%. 1 hr – 50%. 0.5 hr – 75%. 0 hr – 100%.

▲) Standard operating mode: 16,582 kWh, 100% continuous running
 *) Amortization depends on national energy cost

Superb performance, global service

Thanks to its high-grade, low-wear-and-tear components, the Schindler 9500AE inclined moving walk is a product with superb quality and performance. Wherever you are, Schindler global services protect your long-term investment.

Superb performance comes from stringent design

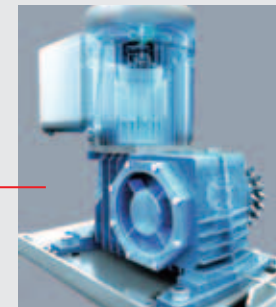
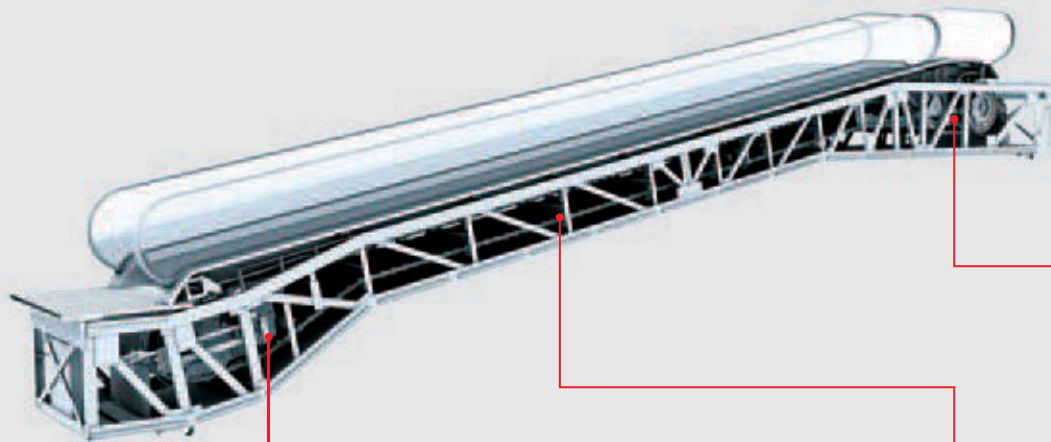

Quiet running – quiet drive units

The Schindler 9500AE inclined moving walk is quieter in operation than other leading commercial moving walk brands.



Long service life

Schindler is committed to designing for a service life of over 20 years. For example, the microprocessor-controlled lubrication system, which feeds the precise amount of lubricant to every lubrication point. Such attention to detail ensures a long service life for all mechanical parts.

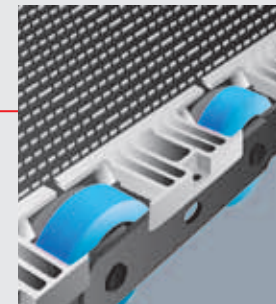

Smooth operation

Schindler uses hydrolysis-resistant polyurethane pallet chain rollers. These are the most reliable rollers on the market. They ensure smooth running even in tropical and subtropical regions.

Long-term returns start with high-quality products and services

Unified global production system boasts European design concepts

Across the globe, Schindler operates nine production units for escalators and moving walks and the key escalator and moving walk components like pallets, trusses, and controllers. The Shanghai plant is by far the biggest escalator and moving walk plant in the industry. All factories produce according to global assembly and quality standards.

Integrated TQM system ensures excellence in quality

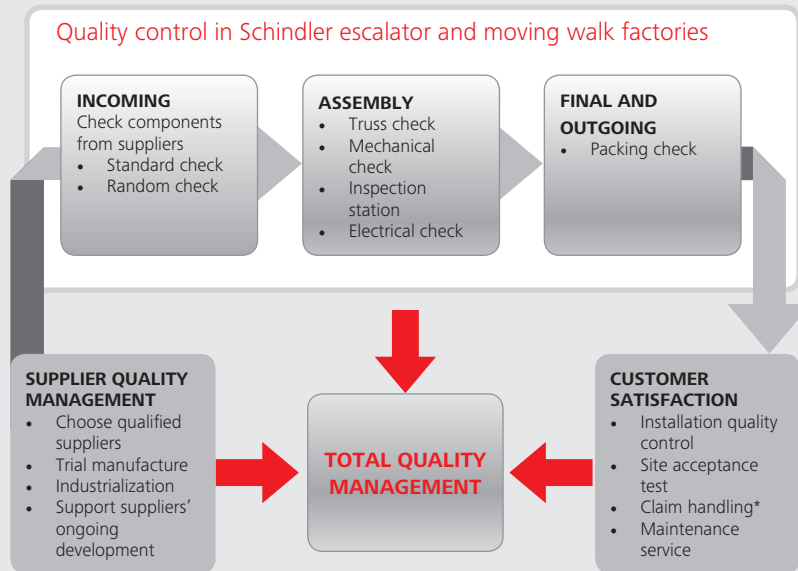

*) In case of claims, such as components damage or missing parts, the factory's special claim handling team will help you analyze them.

Customer-focused maintenance service

Schindler not only has a strict standard maintenance process, it also has a global spare parts supply. By maintaining your moving walk using Schindler-manufactured spare parts, you can be confident it will stay in excellent working order.



Elegant adaptable design options

The Schindler 9500AE inclined moving walk offers you not only timeless basic equipment, but also highly distinctive customized design options that make it easily adaptable to smaller commercial areas and high-end shopping centers.

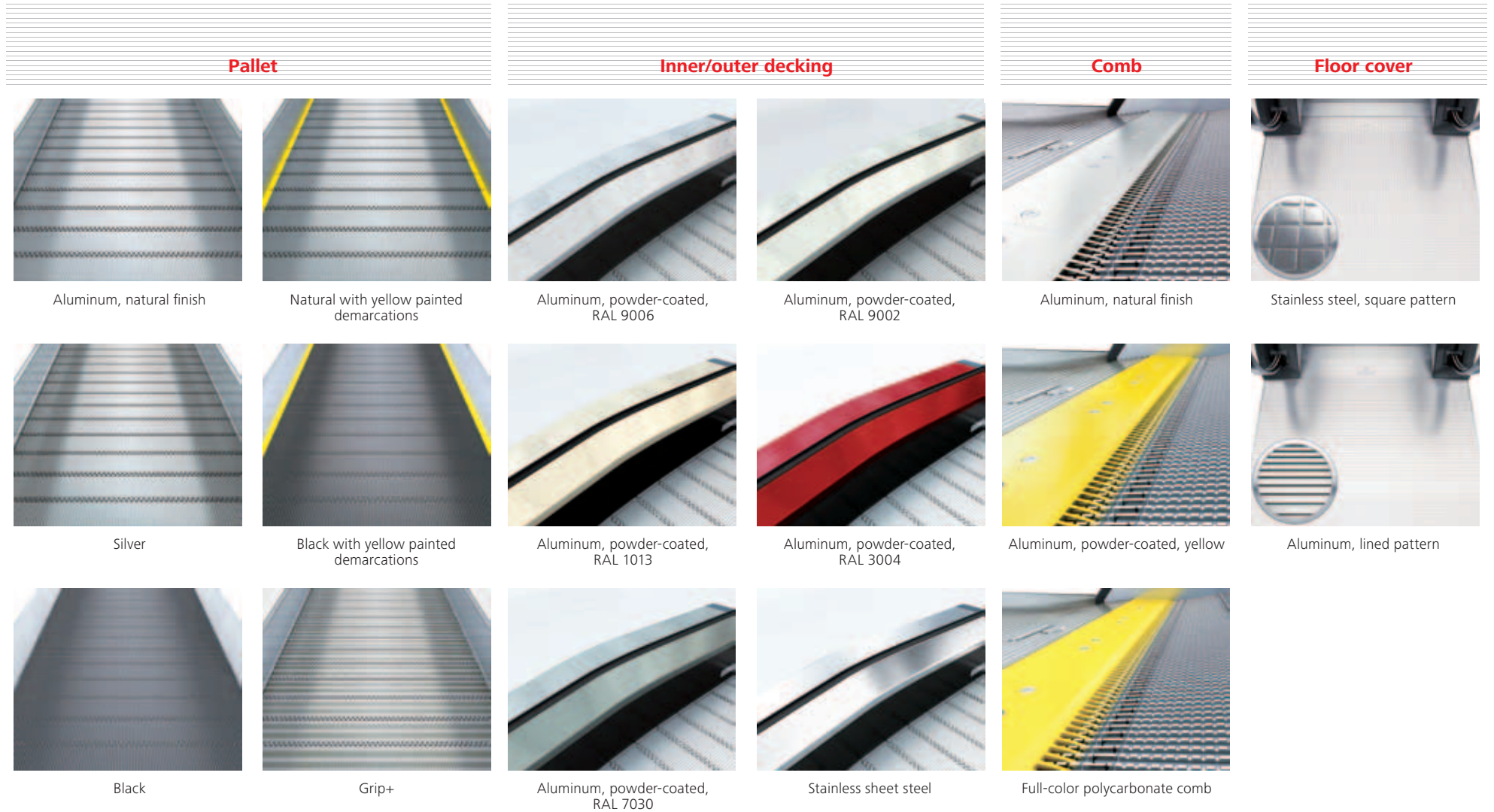



Nothing is unchangeable in our design lines. Our favorite designs just give you an idea of what is possible and can be easily combined. If you like to be more creative, you can even completely design your own moving walk.

Truss cladding



Powder-coated, RAL 9006

LED lighting



E balustrade lighting

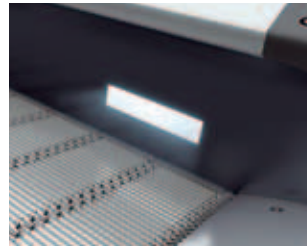

Comb lighting

Handrail



Black



Green

Skirt panel

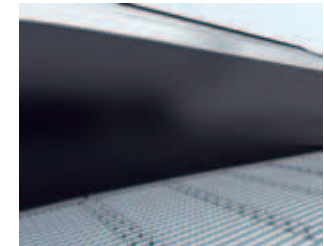

Sheet steel,
black anti-friction

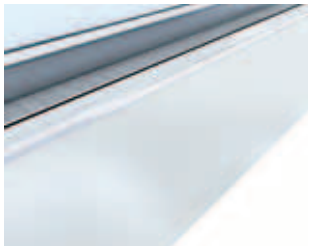

Powder-coated, RAL 9002



Skirt lighting with spots

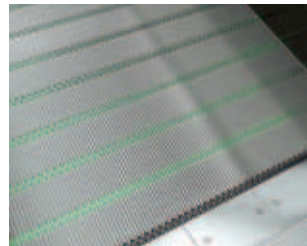

Pallet gap lighting



Red



Orange

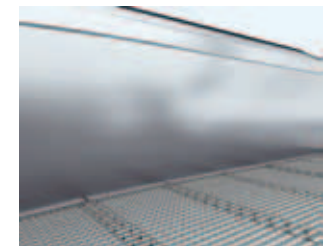

Stainless steel

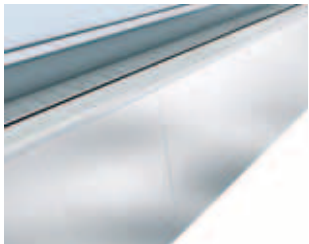

Stainless sheet steel



Skirt lighting with light strip



Soffit lighting



Blue

Note:

Specifications options, and colors are subject to change. All options illustrated in this brochure are representative only. The samples shown may vary from the original in color and material.



PROJECT: Daning International Commercial Plaza
Location: Shanghai, China
Units: 12



Schindler's Grip+

The ultimate anti-slip solution

Schindler's Grip+ is a smart, innovative, and cost-effective solution for inclined moving walks: partial coating of the pallets with carbide. This groundbreaking technology, patented by Schindler, significantly reduces the risk of slipping.

First-rate slip resistance – even on steep inclines

Schindler's high-quality anti-slip coating has been certified to DIN 51130, the standard for measuring the slip resistance of floor coverings, achieving the highest available classification – R13 (slip-resistant at an inclination of over 35 degrees).

Maximum safety – Schindler's patented technology

The carbide coating is an integral part of the pallet, instead of simply being applied after the pallet has been produced. The surface is extremely hard yet smooth and will not hurt passengers or damage passengers' shoes.

Greater durability – even under heavy stress

A stress test yielded the following two facts:

- Exposed to normal wear and tear, the moving walk would remain slip-resistant for about ten years.
- Even after six million visitors had used the moving walk, it still met the requirements for the R10 standard.

DIN 51130 R-value slipperiness classification

Adjusted mean acceptable angle of inclination	Classification
6° to 10°	R9
Over 10°, up to and including 19°	R10
Over 19°, up to and including 27°	R11
Over 27°, up to and including 35°	R12
Over 35°	R13

Schindler's Grip+

Slip-resistant

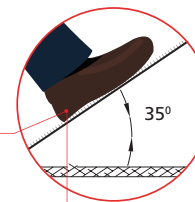

Schindler Grip+		Other brands
Type of surface	Smooth surface with micro-grip	Rough surface or rubber surface
Technology	High-speed spray	<ul style="list-style-type: none"> - Molecular aluminum coating - Electric arc spray - Die-casting/grooves in the pallet - Cold vulcanization
Coating material	Carbide	<ul style="list-style-type: none"> - Aluminum - Aluminum-silicone alloy - Rubber in the grooves - Rubber
Operating lifespan	10 years	<ul style="list-style-type: none"> - 6–12 months - Manufacturers' claim: 3–6 years
Summary	Long lifespan; pallets can be replaced quickly with minimum downtime	<ul style="list-style-type: none"> - Short lifespan - Low slip resistance - Replacing pallets is costly and time-consuming - Higher maintenance costs

Recommended applications for Grip+

Indoors	The moving walk is situated near an exit and is exposed to the elements.
	The moving walk is situated near the entrance or exit of a car park and is exposed to the elements.
	The moving walk has an incline of 12° or more.
Outdoors (covered and uncovered)	The moving walk is exposed to the elements.



Schindler 9500AE inclined moving walks

Planning data

Nominal pallet width [mm]	Angle of inclination [degrees]	Max. rise H [m]	Speed [m/s]	Installation
800	10 11 12	9.3	0.5 0.65	Indoor Outdoor covered Outdoor
1,000	10 11 12	7.5	0.5 0.65	Indoor Outdoor covered Outdoor
1,100	10 11 12	7.5	0.5 0.65	Indoor Outdoor covered Outdoor



Interactive configuration with SchindlerDraw

For project-specific configurations we recommend SchindlerDraw, the interactive online configuration tool available at www.schindler.com.

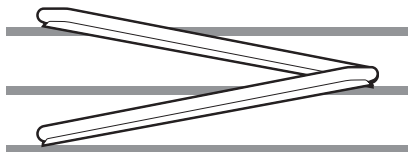

Continuous arrangement
(one-way traffic)

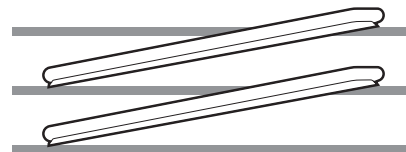

Interrupted arrangement
(one-way traffic)

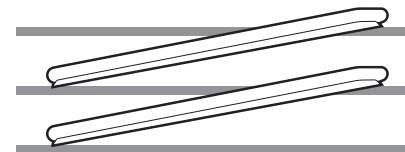

Parallel interrupted arrangement
(two-way traffic)

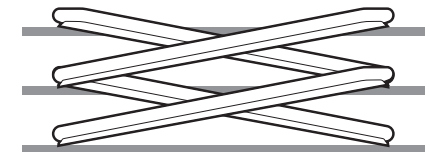

Crisscross continuous arrangement
(two-way traffic)

How do you choose the angle of inclination of moving walks?

Inclinations of 10°, 11°, and 12° are the common international standard for inclined moving walks. Users find that a 10° inclination provides the most comfortable ride. A 12° inclination is used whenever space is limited.

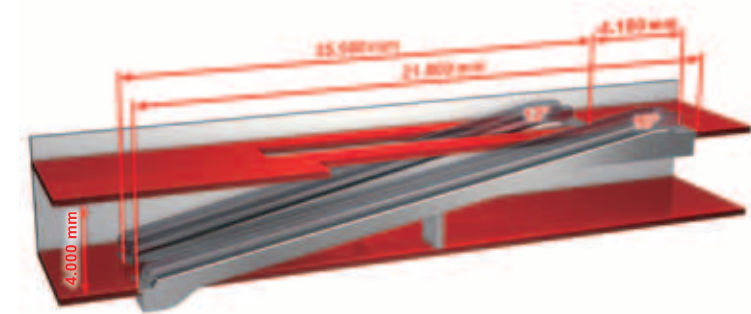

What will determine the width of moving walks?

The width of each shopping or baggage cart and its contents must be at least 400 mm less than the nominal pallet width, since passengers must be able to walk past any cart on the moving walk.

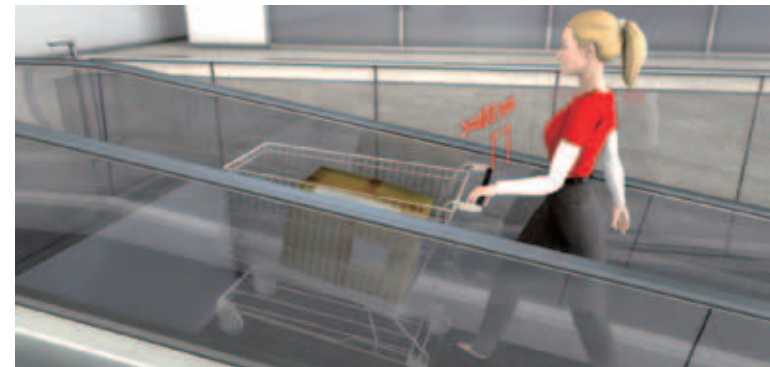

Why should we plan free spaces for moving walks?

To ensure safe use of the moving walks, a sufficient amount of free space must be provided at the upper and lower landings (see the figure for minimum dimensions according to EN 115-1).

For moving walks that are expected to have a high traffic volume and that are also designed for transporting shopping and baggage carts, the free spaces should have a length of at least 5 m. Passenger guide bars, as shown in the picture to the right, need to be installed outside the free space, otherwise special regulations according to EN 115-4 have to be applied.



Schindler 9500 Advanced Edition

Type 10

Rise: max. 7.5 m at a pallet width of 1,000 mm
Balustrade: design E

Balustrade height: 900 / 1,000 mm
Inclination: 10° / 11° / 12°

Pallet width: 800 / 1,000 / 1,100 mm
Horizontal pallet run: 400 mm

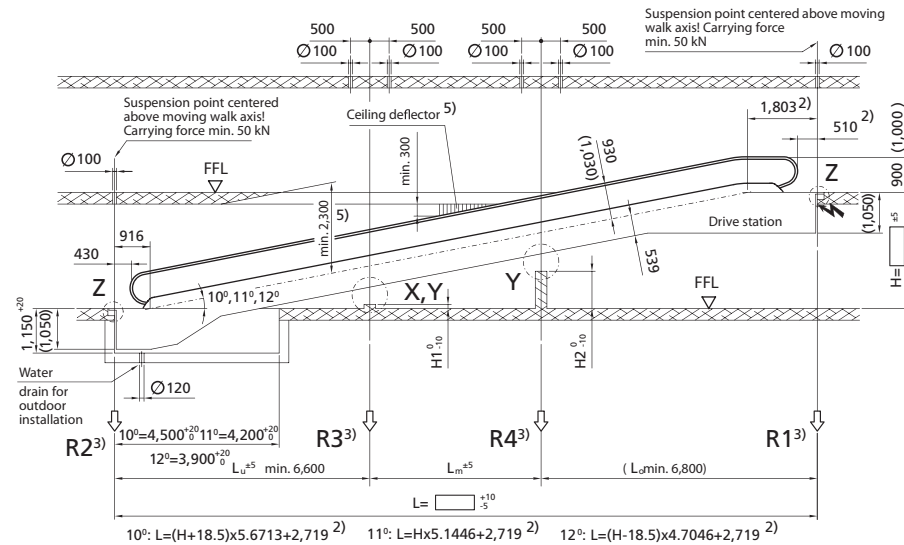

Transportation dimensions

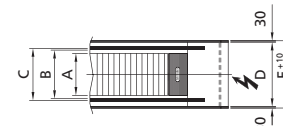
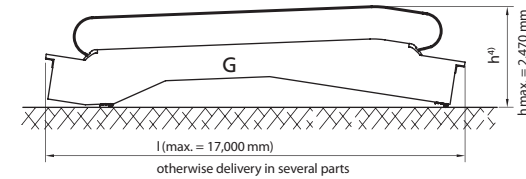

Detail Z

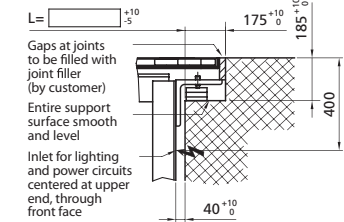

Detail X

One intermediate support

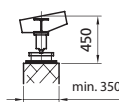

Detail Y

At least two intermediate supports

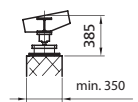

Inclination mm	Rise H mm	Length L	Transp. dimensions in one part		Pallet width A=800			Pallet width A=1,000			Pallet width A=1,100											
					Weight (kN)			Supp. loads (kN)			Weight (kN)			Supp. loads (kN)								
			h ⁴⁾	l	G	Gu	Go	R1	R2	R3	G	Gu	Go	R1	R2	R3	G	Gu	Go	R1	R2	R3
10°	3,000	19,838	2,460	20,420	86	39	47	40	34	92	92	42	50	44	39	108	95	44	52	46	42	116
	4,000	25,509	2,470	26,180	104	48	56	46	41	119	111	51	60	53	47	139	115	53	62	57	50	149
	5,000	31,180	2,470	31,940	130	61	69	56	50	148	143	67	76	70	61	168	150	70	80	77	67	178
12°	3,000	16,746	2,460	17,380	77	34	43	36	30	78	82	37	45	40	35	91	85	39	46	42	38	98
	4,000	21,450	2,470	22,190	93	42	51	42	36	100	99	45	54	47	41	117	102	47	56	50	44	126
	5,000	26,155	2,470	27,000	106	49	57	47	41	122	116	54	62	56	48	143	121	57	65	61	52	154

1) Calculated on the basis of a deflection of L / 750.
 If L > L_{max}, an intermediate support may be required; please consult Schindler.
 Intermediate support (R3) at a distance of L / 2.
 2) With a double drive, the truss must be extended by 417 mm.

3) Support loads for two intermediate supports on request.
 4) Dimensions for balustrade height of 1,000.
 5) Free spaces, overhead clearance, safety clearance; ceiling deflectors, wedging guards, and protective barriers according to national regulations (optional supply by Schindler).

Pallet width	800	1,000	1,100
A: Pallet width	800	1,000	1,100
B: Width between handrails	958	1,158	1,258
C: Handrail center distance	1,038	1,238	1,338
D: Moving walk width	1,340	1,540	1,640
E: Width of pit	1,400	1,600	1,700
L _{max} ¹⁾ : Limiting span length	16,300	15,000	14,300
H _{max} : Maximum rise	9,300	7,500	7,500

All dimensions in mm.
 Observe national regulations!
 Subject to changes.
 INT = intermediate support(s)

Schindler 9500 Advanced Edition

Type 15

Rise: max. 7.5 m at a pallet width of 1,000 mm
Balustrade: design E

Balustrade height: 900 / 1,000 mm
Inclination: 10° / 11° / 12°

Pallet width: 800 / 1,000 / 1,100 mm
Horizontal pallet run: 400 mm

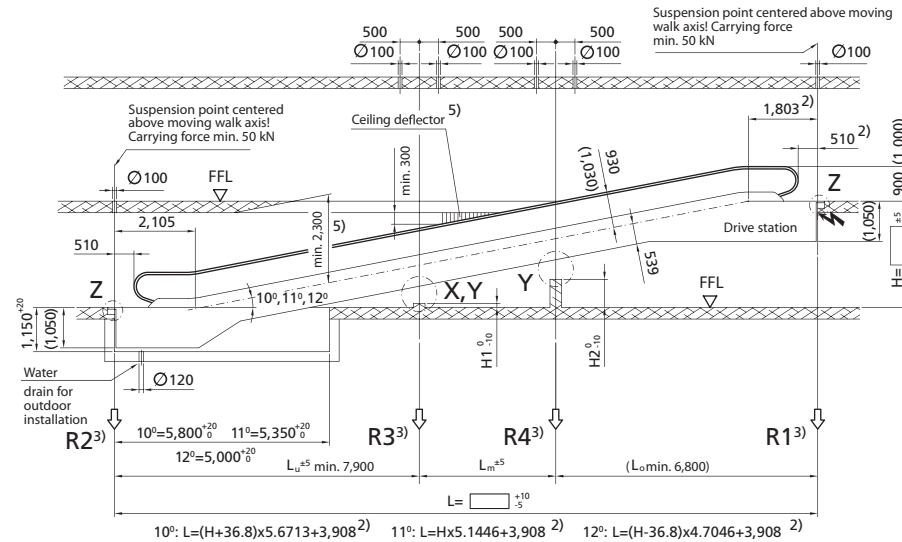

Transportation dimensions

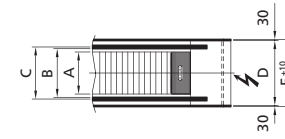
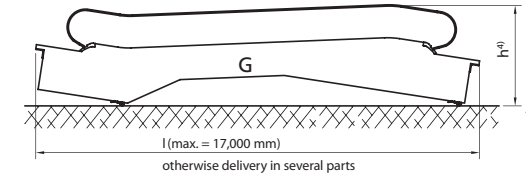

Detail Z

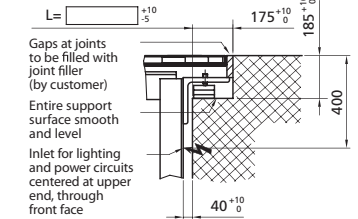

Detail X

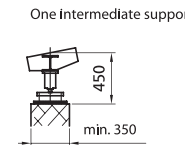

Detail Y

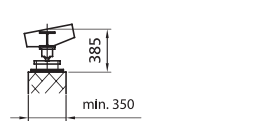

Inclination mm	Rise H mm	Length L	Transp. dimensions in one part		Pallet width A=800						Pallet width A=1,000						Pallet width A=1,100					
					Weight (kN)			Supp. loads (kN)			Weight (kN)			Supp. loads (kN)			Weight (kN)			Supp. loads (kN)		
					h ⁴⁾	I	G	Gu	Go	R1	R2	R3	G	Gu	Go	R1	R2	R3	G	Gu	Go	R1
10°	3,000	21,131	2,460	21,700	92	41	51	41	36	100	99	45	54	47	41	117	103	47	56	50	44	126
	4,000	26,802	2,470	27,460	110	50	60	48	43	126	117	54	63	55	49	147	121	56	65	59	52	158
	5,000	32,473	2,480	33,210	137	64	73	58	53	156	150	70	80	72	64	177	157	73	84	79	70	188
12°	3,000	17,849	2,460	18,460	82	36	46	38	32	84	88	39	49	42	37	98	91	41	51	44	40	105
	4,000	22,553	2,470	23,270	97	44	53	43	37	107	104	47	57	49	43	125	108	49	59	52	46	134
	5,000	27,258	2,470	28,080	112	51	61	49	43	129	122	56	66	58	50	150	127	59	69	63	54	161

Pallet width	800	1,000	1,100
A: Pallet width	800	1,000	1,100
B: Width between handrails	958	1,158	1,258
C: Handrail center distance	1,038	1,238	1,338
D: Moving walk width	1,340	1,540	1,640
E: Width of pit	1,400	1,600	1,700
L _{max} ¹⁾ : Limiting span length	16,300	15,000	14,300
H _{max} : Maximum rise	9,300	7,500	7,500

Inclination	10°	11°	12°
H1	H1 = Lu x 0.1763 - 1389	H1 = Lu x 0.1944 - 1408	H1 = Lu x 0.2126 - 1427
H2	H2 = H1 + Lm x 0.1763	H2 = H1 + Lm x 0.1944	H2 = H1 + Lm x 0.2126

1) Calculated on the basis of a deflection of L / 750.
 If L > L_{max}, an intermediate support may be required; please consult Schindler.
 Intermediate support (R3) at a distance of L / 2.
 2) With a double drive, the truss must be extended by 417 mm.

3) Support loads for two intermediate supports on request.
 4) Dimensions for balustrade height of 1,000.
 5) Free spaces, overhead clearance, safety clearance; ceiling deflectors, wedging guards, and protective barriers according to national regulations (optional supply by Schindler).

All dimensions in mm.
 Observe national regulations!
 Subject to changes.
 INT = intermediate support(s)





For more information about our project references, visit www.schindler.com.

From the subway to the skyline. Providing urban mobility.

Mobility is an essential requirement in the world in which we live and work. Schindler stands for urban mobility and is recognized as a hallmark of quality and safety. Every day, one billion people worldwide place their trust in Schindler products and services.

Schindler provides urban mobility with elevators, escalators, moving walks, and services that are engineered for efficiency and sustainability. Schindler accompanies the development of buildings from planning and construction to daily operation, thus safeguarding their lifetime value.

Ingenious planning

Selecting the right mobility solution means analyzing the building requirements and calculating the potential traffic patterns. This is at the core of Schindler's planning support to ensure efficient mobility and a convenient journey for passengers. Bringing together global know-how for each individual project.

Schindler planning services:

- Expert consultants for traffic and product planning
- Traffic analysis and calculation service
- Specialized engineering centers for customized configurations
- Planning guidelines and tools to expedite shaft planning, building layout, and product selection/configuration

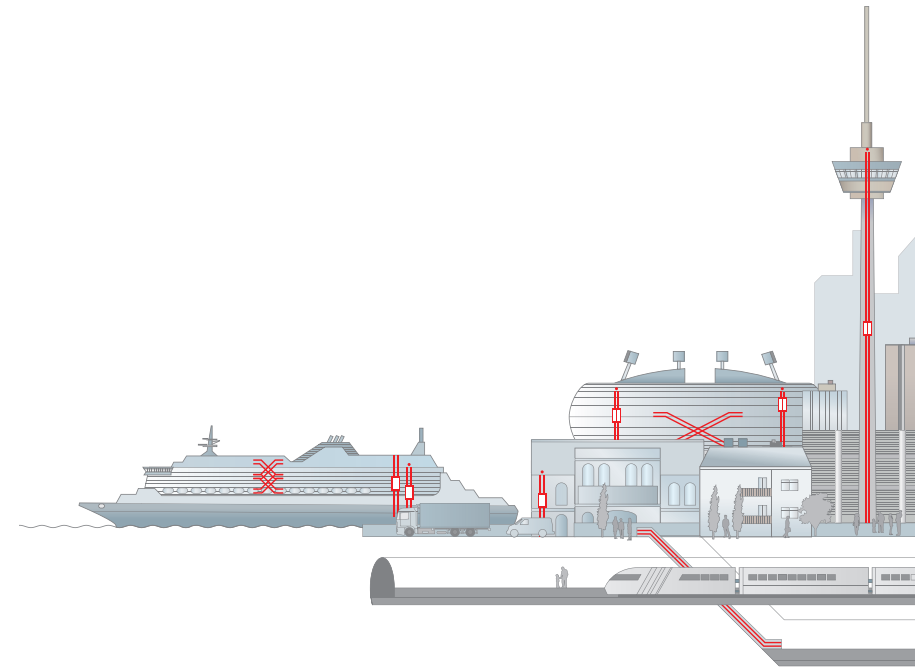

Seamless delivery

With a full-range portfolio of elevators, escalators, and moving walks, Schindler provides mobility solutions for any building application. Schindler customers can rely on sustainable technology, excellent project management, and proven installation methodologies. It's always the perfect fit.

Technology for all building types and mobility needs:

- Residential and office buildings
- Commercial towers, retail environments
- Hospitals and public buildings
- Heavy-traffic environments
- High-rise buildings
- Cruise liners

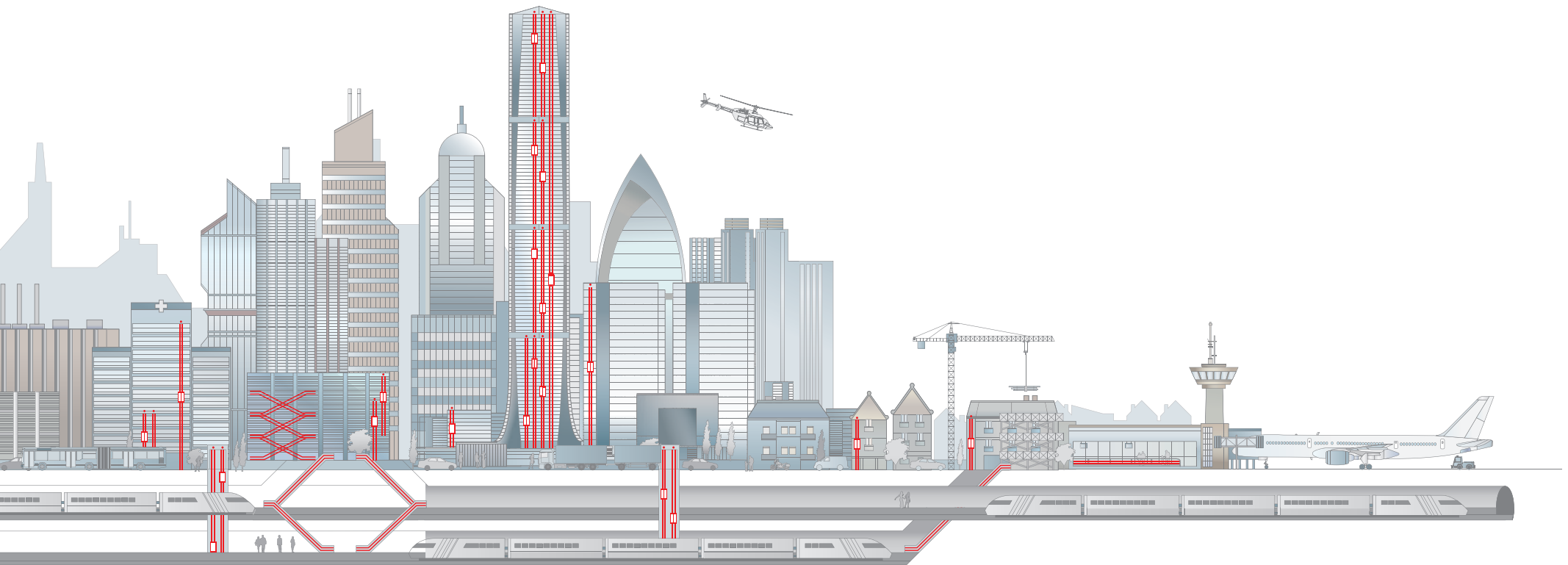

Efficient operation

Smooth, hassle-free operation, and very high availability are the result of professional maintenance and modernization. Environmental and operational efficiency add value to the investment. Reliability and sustainability – all day, every day.

The maintenance, repair, and modernization portfolio:

- Global network of branches and service points
- Skilled and certified technicians and fitters
- Service solutions for all building types and requirements
- Availability and fast delivery of spare parts
- Quickly responding call-center services
- E-monitoring diagnostic tools
- Replacement and step-by-step modernization solutions

Continuous enhancement

Schindler constantly develops new products and features to set new benchmarks and increase efficiency. Technological milestones that provide mobility to the urban society – conveniently, safely, and ecologically. Progress needs innovation.

The cutting-edge developments:

- PORT technology – traffic, building communication, and access-control management that calculates the swiftest route through the building
- Schindler regenerative PF1 clean drive technology
- Space-saving, weight-optimized designs
- Flexible modernization concepts from full replacements to partial retrofits
- Eco-mode options for escalators, moving walks, and escalators

You've made your choice. Now pick your partner.

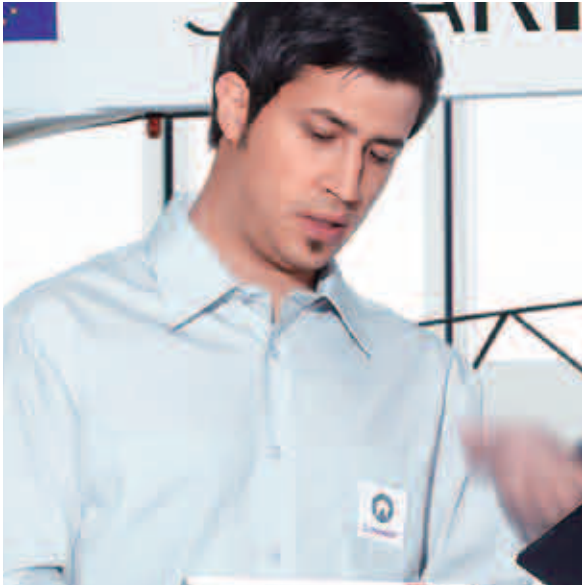

Schindler is a main partner of **Solar Impulse**, the zero-fuel airplane aiming to fly around the world propelled solely by solar energy.

www.schindler.com

Legal Company Name
000 Sample Street
Sample Town 000
Sample Country

Phone 000 000 000 000
Fax 000 000 000 000

xxx@xxx.schindler.com
www.schindler.xx

Legal Company Name
000 Sample Street
Sample Town 000
Sample Country

Phone 000 000 000 000
Fax 000 000 000 000

xxx@xxx.schindler.com
www.schindler.xx

Legal Company Name
000 Sample Street
Sample Town 000
Sample Country

Phone 000 000 000 000
Fax 000 000 000 000

xxx@xxx.schindler.com
www.schindler.xx

Legal Company Name
000 Sample Street
Sample Town 000
Sample Country

Phone 000 000 000 000
Fax 000 000 000 000

xxx@xxx.schindler.com
www.schindler.xx

Legal Company Name
000 Sample Street
Sample Town 000
Sample Country

Phone 000 000 000 000
Fax 000 000 000 000

xxx@xxx.schindler.com
www.schindler.xx